

MALLTIS

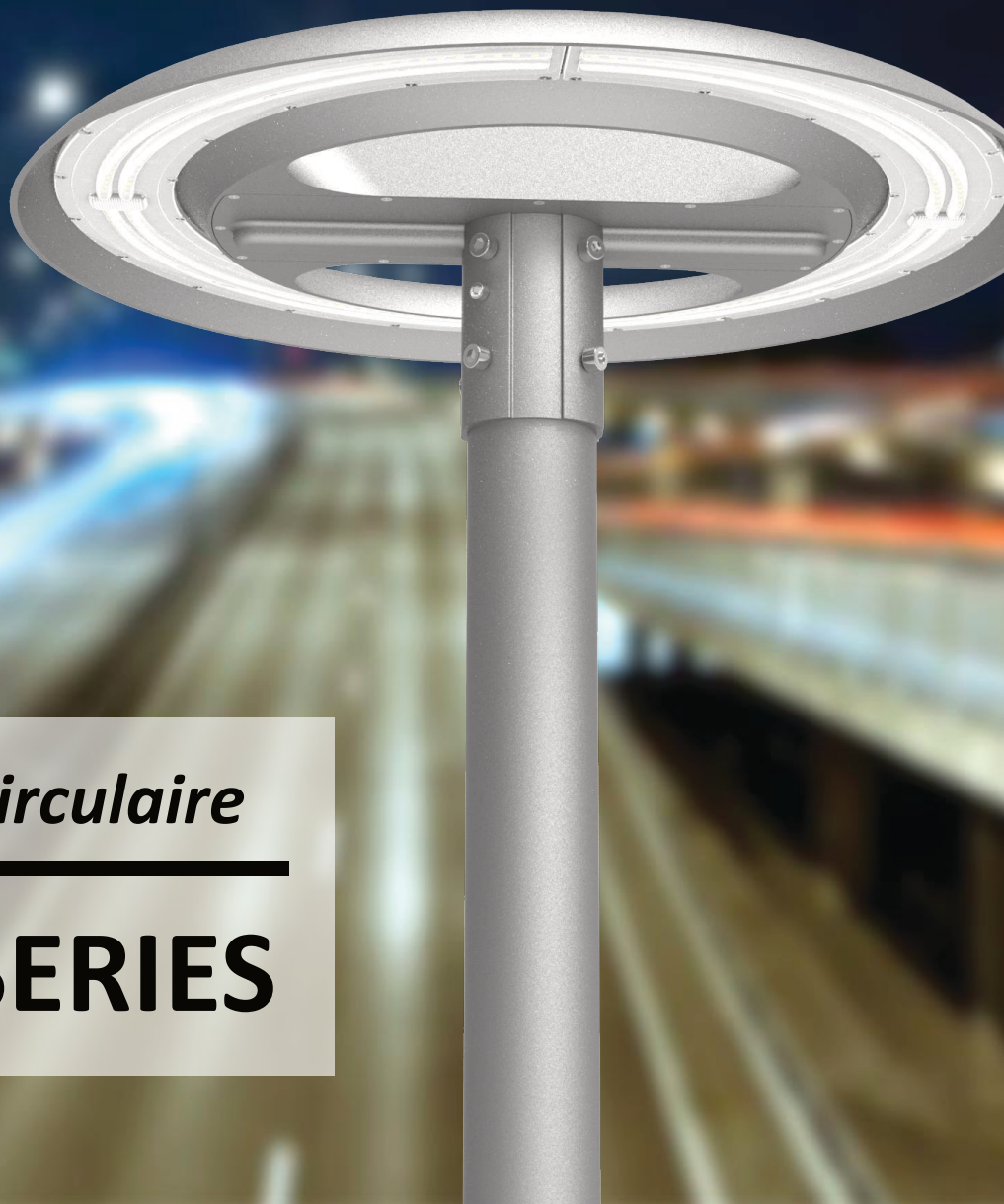

Candélabre circulaire

HALO-L SERIES



RoHS



Idéal pour les parkings, les aires de jeux, les places, les parcs, les golfs et les aires de repos.



GROUPE PRODEAL

11 route de Kerbost - 22200 Grâces
02 96 14 02 05 - info@groupe-prodeal.com



www.groupe-prodeal.com

1

Fonctionnalités

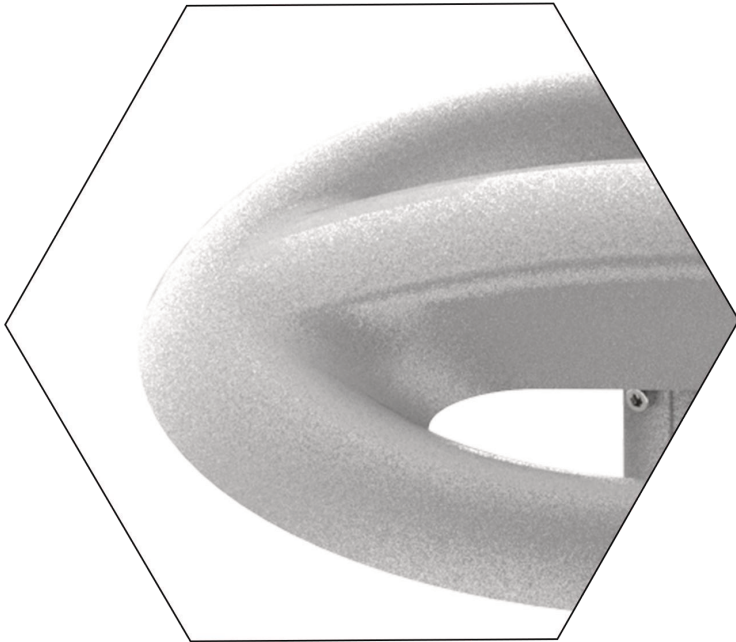

► Design unique

Décoratif en plus d'être fonctionnel

► Surface hydrophobe

Lisse pour éviter d'accrocher la poussière

► Résistant à la rouille

Corps entièrement en aluminium

► Haut rendement

165Lm/w

► IP66

Étanche à l'eau et la poussière

► Résistant

Garantie de 5 ans

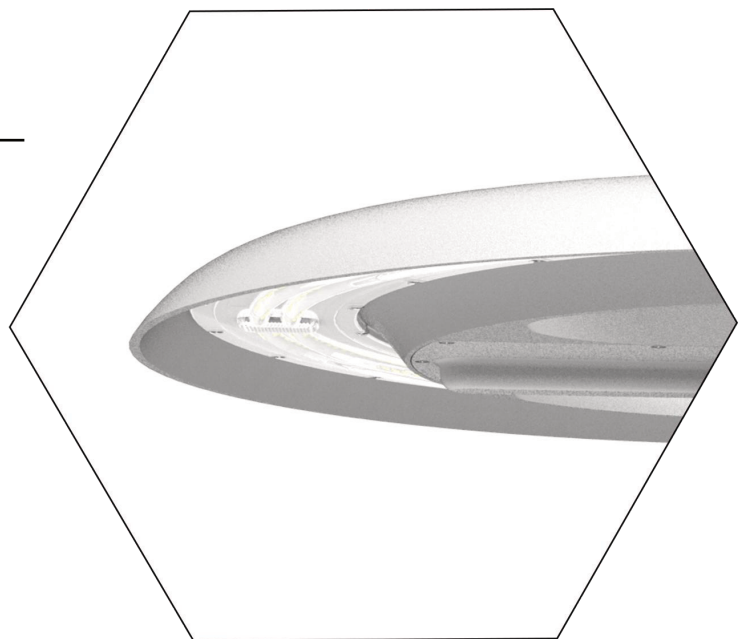

La forme de ce candélabre permet d'obtenir un indice ULOR de 0, et permet ainsi de préserver la biodiversité.

WATT	30/50/80/100/150/200/240W
EFFICACITE	165LM/W \pm 5%
CRI	Ra > 70/80
CCT	2700-6500K
VOLTAGE	AC 100-240V 277V~, 50/60Hz
PF	> 0.95
ANGLE D'ECLAIRAGE	60°/90°/120°
INDICE IP	IP66
TEMP. DE FONCTIONNEMENT	-40°C ~ 60°C
DIAMETRE MAT	60/80mm

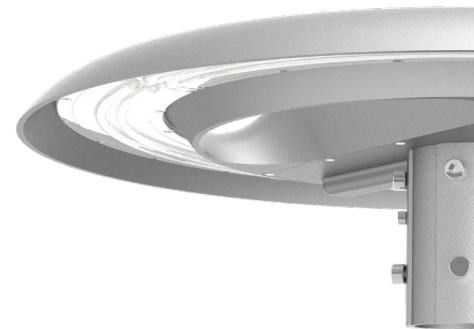

HALO-L50W

8,250LM \pm 5%

3.6kg \pm 5%

ϕ 380*162mm

HALO-L100W

16,500LM \pm 5%

4.1kg \pm 5%

ϕ 380*162mm

HALO-L150W

24,750LM \pm 5%

4.2kg \pm 5%

ϕ 380*162mm

3

Application



4

Test

- Test de montée en température

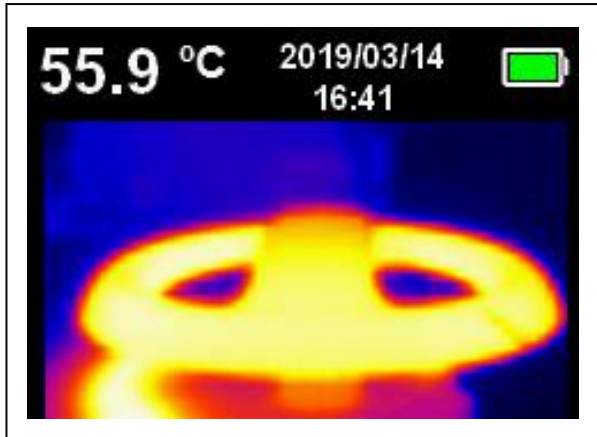

- Brouillard salin

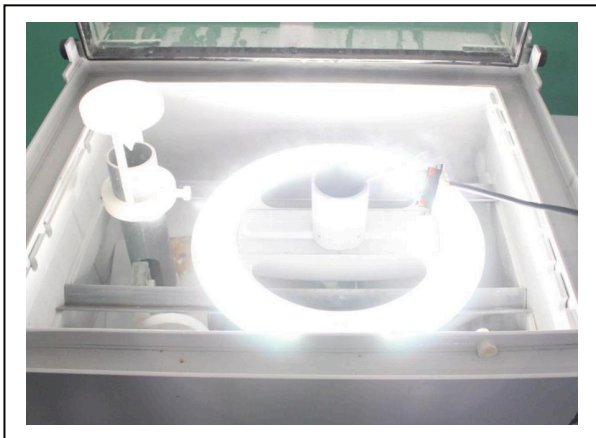

- Test de vibration

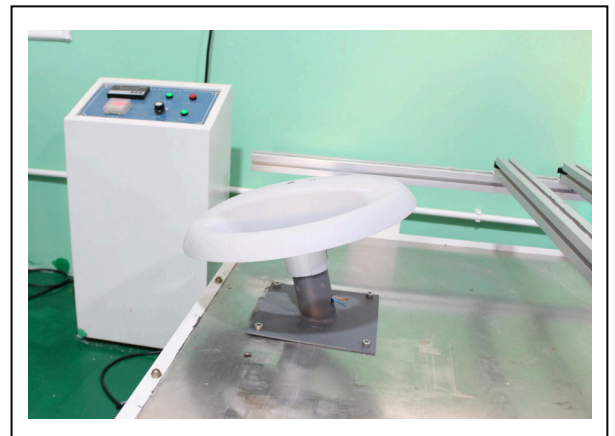

- Test de tension avec résistance

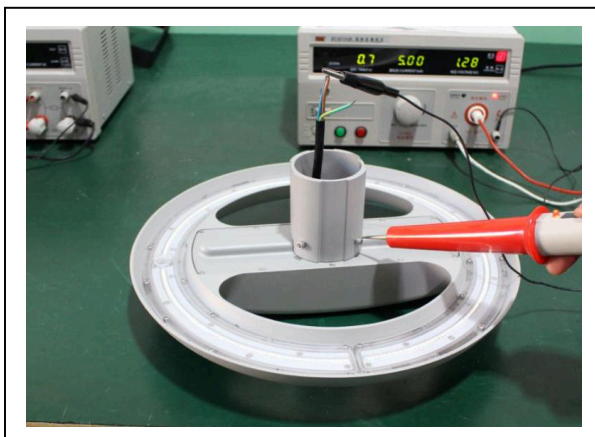

- Test de température haute-basse

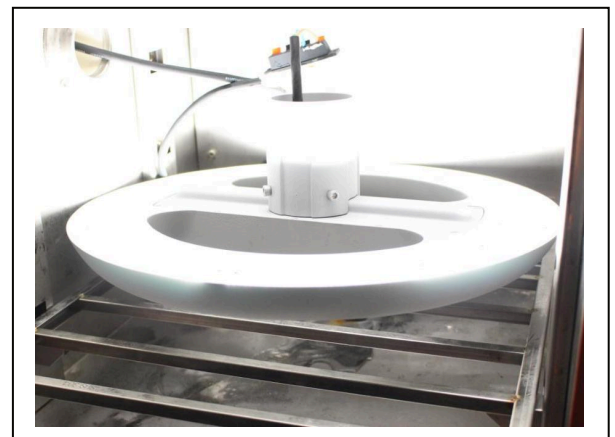

MALLTIS

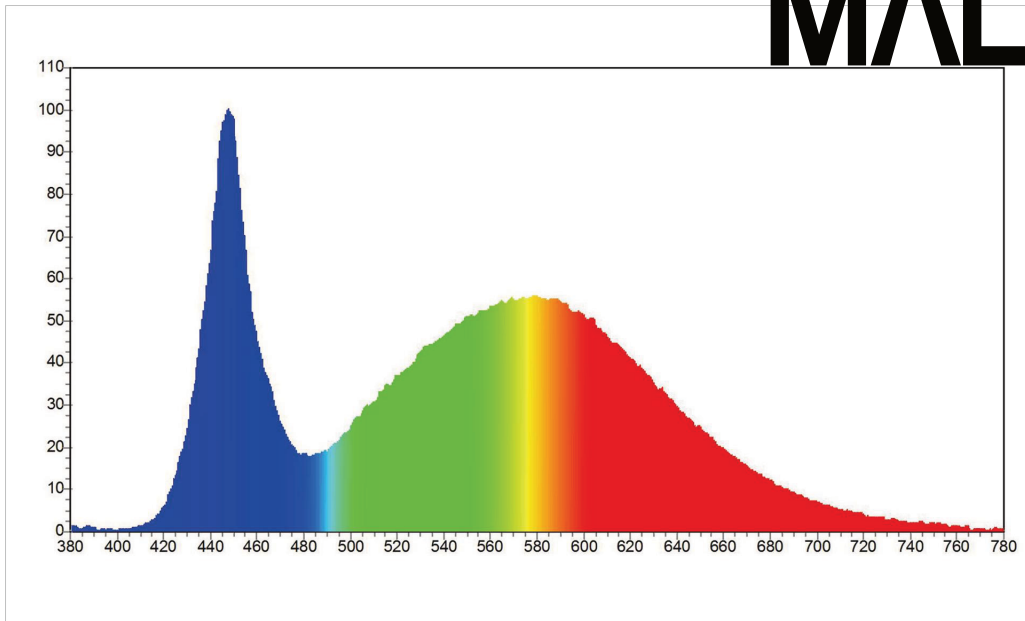

Spectrum Parameters				
x: 0.3393	y: 0.3504	R1: 80.1	R2: 84.8	R3: 85.7
u: 0.2080	v: 0.3221	R4: 80.1	R5: 80.1	R6: 76.1
WD: 566.5 nm	WP: 447.5nm	R7: 81.8	R8: 67.3	R9: 7.1
HW: 23.0 nm	Purity: 0.069	R10: 60.8	R11: 78.2	R12: 58.8
CCT: 5224 K	Ra: 79.5	R13: 80.0	R14: 91.6	R15: 77.8
DUV: 0.0018		R%: 26.9	G%: 43.1	B%: 30.0
Kred 18.71%	Kgreen 76.09%	Kblue 5.20%		
Electrical				
Flux: 33242.298 lm		P: 165.797 lm/w		P: 4247.19 mw
I: 906.4 mA	V: 221.20 V		P: 200.5 w	PF: 0.9650

5

Photométrie

60° / 90° / 120° disponible



60°



90°

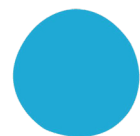

120°

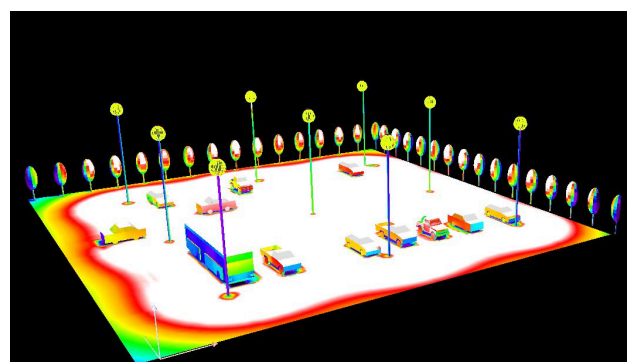
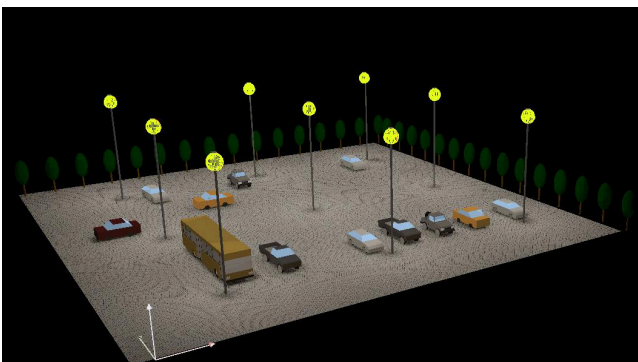

6

Dimensions

MALLTIS

Type A: 380mm series

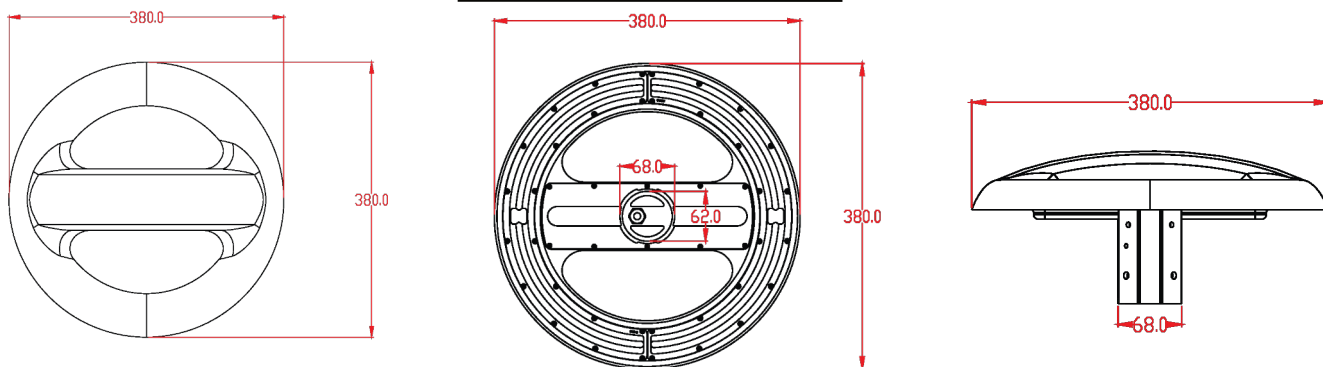

Wattage	Net Weight	Size of Box	Cross Weight	Size of Carton	Gross Weight	Box Quantity / Carton
80482	3.6kg ± 5%	44x43x19cm	6.0kg ± 5%	45x45x77cm	22.5kg ± 5%	4
80483	4.1kg ± 5%	44x43x19cm	6.5kg ± 5%	45x45x77cm	24.5kg ± 5%	4
80479	4.2kg ± 5%	44x43x19cm	6.5kg ± 5%	45x45x77cm	24.5kg ± 5%	4

