



GROUPE
pro
deal

L'éclairage constructif

PRÉSENTATION

Depuis de nombreuses années, le groupe PRODEAL propose des solutions d'éclairage grand public et professionnelles.

PRODEAL s'est doté de capacité d'ingénierie capable de superviser la qualité de ses approvisionnements, de concevoir des solutions à la demande et d'entrer dans l'ère du tout connecté.

Toujours plus pointu et plus exigeant, PRODEAL évolue et se développe depuis plusieurs années avec de nouveaux partenariats commerciaux et techniques pour accélérer sa croissance.

PRODEAL, c'est votre expert éclairage, votre spécialiste de la lumière centré sur une compétence unique. L'architecte de vos linéaires d'ampoules pour les revendeurs, le concepteur/designer de l'éclairage pour les installateurs.

NOS MARQUES

Parce que les besoins des clients sont multiples, nous avons segmenté nos marques commerciales

Occuper tous les segments du marché, c'est répondre aux attentes des différents consommateurs en offrant un choix de produits variés.

MALLTIS

Notre marque PRO

C'est le choix de la performance, avec des produits atteignant 200 lumens/watt consommé par exemple. Une garantie de 5 ans en moyenne et une gamme modulable et conçue sur mesure.

ELUZIA

Notre marque grand public et semi-pro

Positionnement généraliste, Eluzia propose les 20/80, mais aussi une large gamme de classe B en verre claire et Milky, pour un prix proche des SMD de classe E ou F.

plus grand nombre.

EXOLIGHT

Notre gamme discount

Gamme courte, composée de lots, avec la vocation d'être vos produits d'appel et de promotion et ainsi d'épargner votre fonds de rayon.



Picto qui indique des fonctions polyvalente pour rationaliser vos stocks

RELAMPING

Nos experts PRODEAL vous accompagnent pour l'éclairage de vos parkings, de vos magasins, entrepôts et bureaux.



Nous vous proposons également une solution exclusive d'éclairage de gondole s'adaptant à tous les mobiliers existants.

Pour faciliter vos choix et vous aider à vous projeter, nous réalisons des études d'éclairage déterminant l'éclairage optimal pour vos locaux, bureaux, surfaces commerciales ainsi que vos espaces extérieurs.

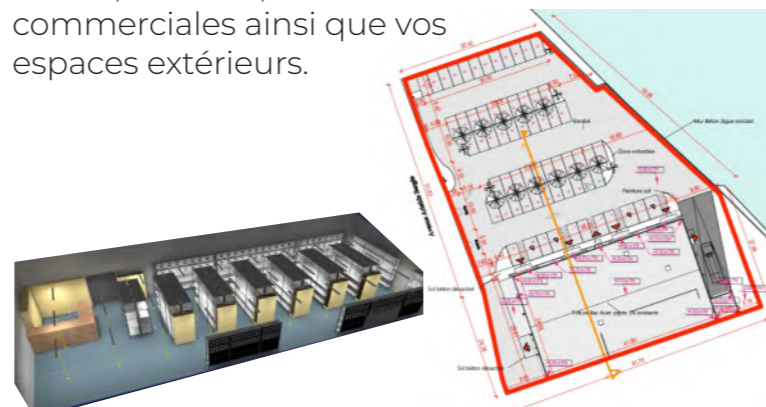

BUREAU D'ÉTUDE

Un bureau d'études, toujours à l'écoute de nos clients et de leurs besoins les plus pointus, PRODEAL a su innover en développant de nombreuses gammes.

Ce sont aussi des choix techniques originaux et de confort qui permettent de se démarquer résolument.

La qualité est au cœur de notre approche, tous nos produits bénéficient d'un ERP, gage d'une conception haut de gamme et sans concession à la fiabilité.

l'ERP, c'est 6 000 heures de test en continu, avec 80 % du flux lumineux minimum restitué au terme de ce délai (directive EN 1194/2011)

SOMMAIRE

Page	Rubrique
04	Ampoules MALLTIS
06	PAR16 & LINOLITE
08	Ampoules LED FILAMENT ELUZIA
12	Ampoules LED SMD ELUZIA
14	Ampoules EXOLIGHT
16	Ampoules spéciales
17	Tubes LED
18	Luminaires
19	Projecteurs
20	Réglettes étanches ELUZIA
21	Panel Eluzia
22	Réglettes étanches Malttis
23	High Bay Malttis
24	Panel Malttis
25	Hublot anti-vandal
26	Rouleaux LED
27	Projecteurs de chantier
28	Projecteurs hybride
29	Eclairage sur batterie

PICTOS

- Fourreau brochable
- Emballage brochable
- Blister
- Emballage boîte carton non brochable
- Emballage boîte carton brochable
- Nouveauté
- Jusqu'à épuisement des stocks
- Prochainement
- Indice de rendu des couleurs



AMPOULE LED FILAMENT

Photo	Ref	Culot	Watts	W=	Lumen	°K	Angle	Varia.	IRC	Finit.	Ø (mm)	H (mm)	UVC	N.B.	TM
GLOBE															
	15930	E27	4	25	250	2 200	320	Oui	90	Clair	80	120	⊕	1 2	MALLTIS G
	15901	E27	8	60	800	2 200	360	Non	80	Ambré	95	135	⊕	1 2	MALLTIS F
ST64															
	15900	E27	6	51	600	2 200	320	Non	80	Ambré	64	146	⊕	1 2	MALLTIS F
STANDARD															
	15987	B22	7	50	770	3 000	320	Oui	90	Clair	60	110	⊕	1 6	MALLTIS E
	15988	B22	7	50	770	4 000	320	Oui	90	Clair	60	110	⊕	1 6	MALLTIS E
	15992	B22	3,8	60	806	3 000	320	Non	80	Clair	60	105	⊕	1 10	MALLTIS A
	15993	B22	3,8	60	806	4 000	320	Non	80	Clair	60	105	⊕	1 10	MALLTIS A
	15996	B22	7	100	1 521	3 000	320	Non	80	Clair	60	105	⊕	1 10	MALLTIS A
	15997	B22	7	100	1 521	4 000	320	Non	80	Clair	60	105	⊕	1 10	MALLTIS A
	15933	E27	3	15	150	2 200	320	Oui	90	Clair	60	100	⊕	1 6	MALLTIS G
	15934	E27	7	55	770	3 000	320	Oui	90	Clair	60	100	⊕	1 10	MALLTIS E
	15935	E27	7	55	770	4 000	320	Oui	90	Clair	60	100	⊕	1 10	MALLTIS E
	15990	E27	3,8	60	806	3 000	320	Non	80	Clair	60	105	⊕	1 10	MALLTIS A
	15991	E27	3,8	60	806	4 000	320	Non	80	Clair	60	105	⊕	1 10	MALLTIS A
	15994	E27	7	100	1 521	3 000	320	Non	80	Clair	60	105	⊕	1 10	MALLTIS A
	15995	E27	7	100	1 521	4 000	320	Non	80	Clair	60	105	⊕	1 10	MALLTIS A
MINI SPHERIQUE															
	15047	B22	2,5	20	250	2 700	320	Non	80	Clair	45	72	⊕	1 10	MALLTIS F
	15051	B22	4	40	400	2 700	320	Non	80	Clair	45	74	⊕	1 10	MALLTIS F
	15936	E27	2	15	100	2 200	320	Oui	90	Clair	45	74	⊕	1 6	MALLTIS G
	15046	E27	2,5	20	250	2 700	320	Non	80	Clair	45	74	⊕	1 10	MALLTIS F
	15048	E27	4	40	400	2 700	320	Non	80	Clair	45	74	⊕	1 10	MALLTIS F
	15937	E27	5	35	400	3 000	320	Oui	90	Clair	45	74	⊕	1 6	MALLTIS G
	15938	E27	5	35	400	2 200	320	Oui	90	Clair	45	74	⊕	1 6	MALLTIS G
SPOT R60															
	15049	E27	2	20	200	2 700	180	Non	80	Clair	63	105	⊕	1 10	MALLTIS F

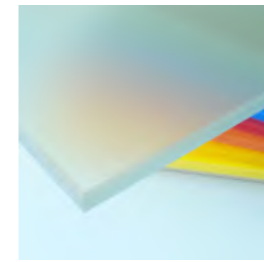

Avantage du verre dépoli extérieur :
pas de reflet aspect authentique



Référence Eluzia - obtenu par poudrage intérieur

Photo	Ref	Culot	Watts	W=	Lumen	°K	Angle	Varia.	IRC	Finit.	Ø (mm)	H (mm)	UVC	N.B.	TM
FLAMME LISSE															
	15931	E14	2	15	100	2 200	320	Oui	90	Clair	36	110	⊕	1 6	MALLTIS G
	15932	E14	4	35	380	4 000	320	Oui	90	Clair	36	100	⊕	1 6	MALLTIS F
	16302	E14	5	40	450	2 700	320	Non	90	Dépoli	35	100	⊕	1 6	MALLTIS E
FLAMME TORSADÉE															
	16308	E14	7	60	400	2 700	320	Oui	90	Dépoli	35	100	⊕	1 6	MALLTIS E
	16300	E14	4	40	450	2 700	320	Non	90	Dépoli	50	140	⊕	1 6	MALLTIS E
	16309	E14	7	60	806	2 700	320	Oui	90	Dépoli	35	100	⊕	1 6	MALLTIS E
	16301	B22	4	40	450	2 700	320	Non	90	Dépoli	50	140	⊕	1 6	MALLTIS E
	16305	E27	4	40	400	2 700	320	Non	90	Dépoli	50	140	⊕	1 6	MALLTIS E
FLAMME COUP DE VENT															
	15902	E14	4	35	400	2 200	360	Non	80	Ambré	35	113	⊕	1 6	MALLTIS F
	16304	E14	4	40	450	2 700	320	Non	90	Dépoli	35	125	⊕	1 6	MALLTIS E
FLAMME CDV DROITE															
	16291	E14	4	25	265	2 700	320	Oui	90	Dépoli	22	89	⊕	1 6	MALLTIS F
	16290	E14	1	10	90	2 700	320	Oui	90	Dépoli	22	89	⊕	1 6	MALLTIS F
	16303	E14	2	25	230	2 700	320	Non	90	Dépoli	35	125	⊕	1 6	MALLTIS E
	16292	E14	4	25	300	2 700	320	Oui	90	Dépoli	35	125	⊕	1 6	MALLTIS F

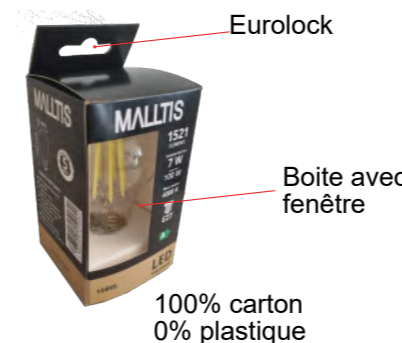
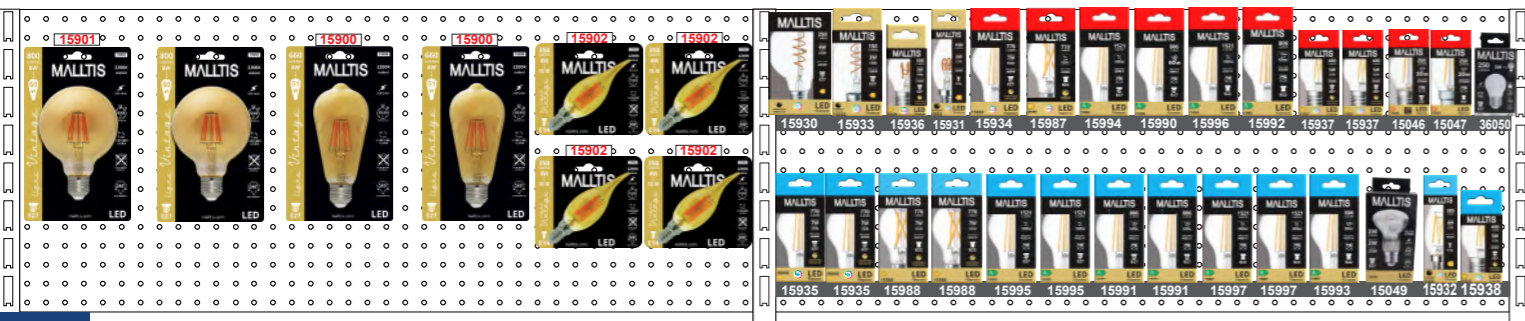

100% carton
0% plastique

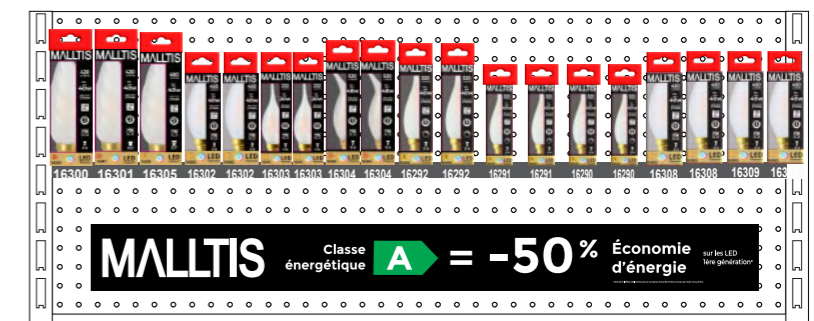



LINOLITE

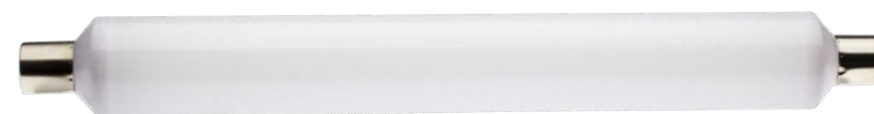

ampoule led SMD

Photo	Ref	Culot	Watts	W=	Lumen	°K	Angle	Varia.	IRC	Finit.	Ø (mm)	H (mm)	UVC	N.B.	TM
SPORT PAR16															
	15939	GU10	5,5	40	420	2 700	36	Oui	95	Opale	50	55	1	10	MALLTIS
	15940	GU10	5,5	40	420	4 000	36	Oui	95	Opale	50	55	1	10	MALLTIS
	15941	GU10	5,5	40	420	5 000	36	Oui	95	Opale	50	55	1	10	MALLTIS

Photo	Ref	Culot	Watts	W=	Lumen	°K	Angle	Varia.	IRC	Finit.	Ø (mm)	H (mm)	UVC	N.B.	TM
LINOLITE															
	11223	S19	9	60	806	3 000	180	Non	90	Opale	38	309	1	10	MALLTIS
	11224	S19	9	60	806	4 000	180	Non	90	Opale	38	309	1	10	MALLTIS

L'IRC (Indice de Rendu de Couleur) indique le niveau de distorsion entre la couleur réelle vue à la lumière du jour et cette même couleur vue sous un éclairage artificiel.



Ce qui distingue la marque

MALLTIS

- Références pour les pro
- Des IRC élevés
- Efficient : 1 watt = 220 lumens
- Garantie 5 ans
- Références dimmables
- Une GU10 5000K
- Dépolie extérieur
- Fab sur mesure^(*)

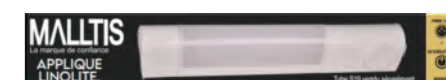

Emballage 100% carton.
Facing horizontal ou verticale

Photo	Ref	Finit.	Culot	l (mm)	L (mm)	H (mm)	Watts	Prise	IP	Max W	PoseUVC	N.B.	TM
APPLIQUE LINOLITE													
	12232	Blanc	S19	70	435	61		1x220V	IP20	60W	1	2	MALLTIS

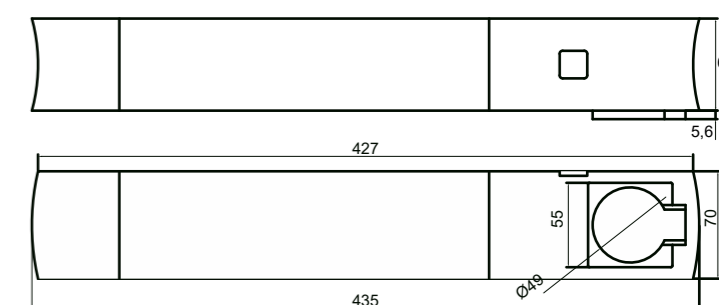

LED Ce luminaire fonctionne avec un tube LED S19 interchangeable.



Tubes recommandés **MALLTIS**

Vendu séparément



Choisissez la température d'éclairage qui vous convient :
↳ 11223 : 9W - 806 lumens - 3000K (blanc chaud) - IRC90
↳ 11224 : 9W - 806 lumens - 4000K (blanc neutre) - IRC90

IRC90 pour une couleur plus naturelle

(*) profilés et ruban LED





LED FILAMENT (COB)

Les LED filament appartiennent à la famille des LED de type COB (Chip On Board). Par rapport à la LED SMD, plusieurs puces miniatures seront inclus dans le substrat phosphorescent. Pour améliorer la refroidissement de ce type de technologie, la LED est mis dans une perle de verre rempli à l'hélium pour améliorer la

AMPOULE LED FILAMENT

Photo Ref		Culot	Watts	W=	Lumen	°K	Angle	Varia.	IRC	Finit.	Ø (mm)	H (mm)	UVC	N.B.	TM
GLOBE															
15329	3661925153294	E27	8	60	806	4 000	320	Non	80	Milky	80	120	⊙	1 2	ELUZIA F
STANDARD															
17842	3661925178426	B22	6	60	1 110	3 000	360	Non	80	Milky	60	105	⊙	1 10	ELUZIA B
17843	3661925178433	B22	6	60	1 110	4 000	360	Non	80	Milky	60	105	⊙	1 10	ELUZIA B
15330	3661925153300	B22	8	60	806	4 000	360	Non	80	Milky	60	105	⊙	1 10	ELUZIA F
16828	3661925168281	B22	4	60	806	4 000	360	Non	80	Clair	60	105	⊙	1 10	ELUZIA B
17827	3661925178273	B22	4	60	806	3 000	360	Non	80	Milky	60	105	⊙	1 10	ELUZIA B
17828	3661925178280	B22	4	60	806	4 000	360	Non	80	Milky	60	105	⊙	1 10	ELUZIA B
15337	3661925153379	B22	12	100	1 521	4 000	360	Non	80	Clair	67	120	⊙	1 10	ELUZIA E
17831	3661925178310	B22	8	60	1 521	3 000	360	Non	80	Milky	60	105	⊙	1 10	ELUZIA B
17832	3661925178327	B22	8	60	1 521	4 000	360	Non	80	Milky	60	105	⊙	1 10	ELUZIA B
16827	3661925168274	B22	4	60	806	3 000	360	Non	80	Clair	60	105	⊙	1 10	ELUZIA B
16831	3661925168311	B22	8	100	1 521	3 000	360	Non	80	Clair	60	105	⊙	1 10	ELUZIA B
16832	3661925168328	B22	8	100	1 521	4 000	360	Non	80	Clair	60	105	⊙	1 10	ELUZIA B
17840	3661925178402	E27	6	60	1 110	3 000	360	Non	80	Milky	60	105	⊙	1 10	ELUZIA B
17841	3661925178419	E27	6	60	1 110	4 000	360	Non	80	Milky	60	105	⊙	1 10	ELUZIA B
15324	3661925153249	E27	8	60	806	2 700	360	Non	80	Milky	60	105	⊙	1 10	ELUZIA F
15326	3661925153263	E27	8	60	806	4 000	360	Non	80	Milky	60	105	⊙	1 10	ELUZIA F
16826	3661925168267	E27	4	60	806	4 000	360	Non	80	Clair	60	105	⊙	1 10	ELUZIA B
17825	3661925178259	E27	4	60	806	3 000	360	Non	80	Milky	60	105	⊙	1 10	ELUZIA B
17826	3661925178266	E27	4	60	806	4 000	360	Non	80	Milky	60	105	⊙	1 10	ELUZIA B
18825	3661925188258	E27	4	60	806	3 000	360	Non	80	Milky	60	105	⊙	4 10	ELUZIA B
18826	3661925188265	E27	4	60	806	4 000	360	Non	80	Milky	60	105	⊙	4 10	ELUZIA B
17829	3661925178297	E27	8	60	1 521	3 000	360	Non	80	Milky	60	105	⊙	1 10	ELUZIA B
17830	3661925178303	E27	8	60	1 521	4 000	360	Non	80	Milky	60	105	⊙	1 10	ELUZIA B
16825	3661925168250	E27	4	60	806	3 000	360	Non	80	Clair	60	105	⊙	1 10	ELUZIA B
16829	3661925168298	E27	8	100	1 521	3 000	360	Non	80	Clair	60	105	⊙	1 10	ELUZIA B
16830	3661925168304	E27	8	100	1 521	4 000	360	Non	80	Clair	60	105	⊙	1 10	ELUZIA B

Photo Ref		Culot	Watts	W=	Lumen	°K	Angle	Varia.	IRC	Finit.	Ø (mm)	H (mm)	UVC	N.B.	TM
MINI SPHERIQUE															
16814	3661925168144	E14	6	78	1 110	3 000	360	Non	80	Clair	45	78	⊙	1 10	ELUZIA B
16815	3661925168151	E14	6	78	1 110	4 000	360	Non	80	Clair	45	78	⊙	1 10	ELUZIA B
17814	3661925178143	E14	6	78	1 110	3 000	360	Non	80	Milky	45	78	⊙	1 10	ELUZIA B
17815	3661925178150	E14	6	78	1 110	4 000	360	Non	80	Milky	45	78	⊙	1 10	ELUZIA B
15316	3661925153164	E14	4	40	470	2 700	360	Non	80	Milky	45	78	⊙	1 10	ELUZIA E
15318	3661925153188	E14	4	40	470	4 000	360	Non	80	Milky	45	78	⊙	1 10	ELUZIA E
16809	3661925168090	E14	2,5	40	470	3 000	360	Non	80	Clair	45	78	⊙	1 10	ELUZIA B
16810	3661925168106	E14	2,5	40	470	4 000	360	Non	80	Clair	45	78	⊙	1 10	ELUZIA B
17809	3661925178099	E14	2,5	40	470	3 000	360	Non	80	Milky	45	78	⊙	1 10	ELUZIA B
17810	3661925178105	E14	2,5	40	470	4 000	360	Non	80	Milky	45	78	⊙	1 10	ELUZIA B
15328	3661925153287	B22	4	40	470	4 000	360	Non	80	Milky	45	78	⊙	1 10	ELUZIA E
17816	3661925178167	B22	2,5	78	470	3 000	360	Non	80	Milky	45	78	⊙	1 10	ELUZIA B
16820	3661925168205	B22	4	60	806	3 000	360	Non	80	Clair	45	78	⊙	1 10	ELUZIA B
16821	3661925168212	B22	4	60	806	4 000	360	Non	80	Clair	45	78	⊙	1 10	ELUZIA B
17820	3661925178204	B22	4	60	806	3 000	360	Non	80	Milky	45	72	⊙	1 10	ELUZIA B
17821	3661925178211	B22	4	60	806	4 000	360	Non	80	Milky	45	72	⊙	1 10	ELUZIA B
16823	3661925168236	E27	6	78	1 110	3 000	360	Non	80	Clair	45	78	⊙	1 10	ELUZIA B
16824	3661925168243	E27	6	78	1 110	4 000	360	Non	80	Clair	45	78	⊙	1 10	ELUZIA B
17823	3661925178235	E27	6	78	1 110	3 000	360	Non	80	Milky	45	72	⊙	1 10	ELUZIA B
17824	3661925178242	E27	6	78	1 110	4 000	360	Non	80	Clair	45	72	⊙	1 10	ELUZIA B
15320	3661925153201	E27	4	40	470	2 700	360	Non	80	Milky	45	74	⊙	1 10	ELUZIA E
15322	3661925153225	E27	4	40	470	4 000	360	Non	80	Milky	45	78	⊙	1 10	ELUZIA E
16817	3661925168175	E27	2,5	40	470	3 000	360	Non	80	Clair	45	78	⊙	1 10	ELUZIA B
16818	3661925168182	E27	2,5	40	470	4 000	360	Non	80	Clair	45	78	⊙	1 10	ELUZIA B
17817	3661925178174	E27	2,5	40	470	3 000	360	Non	80	Milky	45	78	⊙	1 10	ELUZIA B
17818	3661925178181	E27	2,5	40	470	4 000	360	Non	80	Milky	45	78	⊙	1 10	ELUZIA B

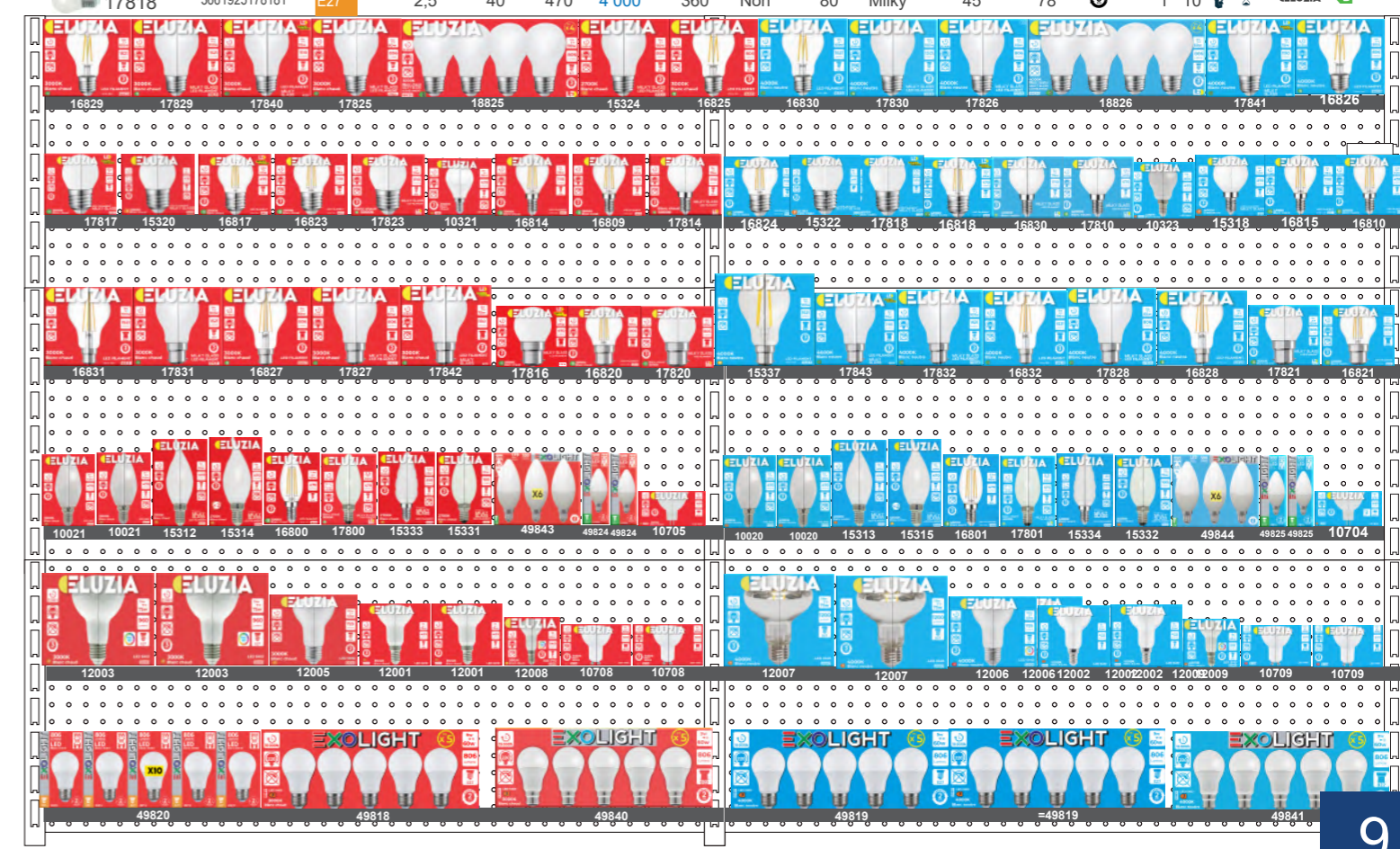



la boîte qui cartonne !



Blanc neutre 4000K

Blanc chaud 3000K

Photo	Ref	Culot	Watts	W=	Lumen	°K	Angle	Varia.	IRC	Finit.	Ø (mm)	H (mm)	UVC	N.B.	TM
FLAMME LISSE															
	15331	3661925153317	E14	1	10	100	3 000	320	Non	80	Milky	36	100	1 10	ELUZIA F
	15332	3661925153324	E14	1	10	100	4 000	320	Non	80	Milky	36	100	1 10	ELUZIA F
	16800	3661925168007	E14	2,5	40	470	3 000	320	Non	80	Clair	35	98	1 10	ELUZIA B
	16801	3661925168014	E14	2,5	40	470	4 000	320	Non	80	Clair	35	98	1 10	ELUZIA B
	17800	3661925178006	E14	2,5	40	470	3 000	320	Non	80	Milky	35	110	1 10	ELUZIA B
	17801	3661925178013	E14	2,5	40	470	4 000	320	Non	80	Milky	35	110	1 10	ELUZIA B
FLAMME TORSADÉE															
	15333	3661925153331	E14	2,5	25	250	3 000	320	Non	80	Milky	36	100	1 10	ELUZIA F
	15334	3661925153348	E14	2,5	25	250	4 000	320	Non	80	Milky	36	100	1 10	ELUZIA F
FLAMME COUP DE VENT															
	15312	3661925153126	E14	4	40	470	2 700	320	Non	80	Milky	35	113	1 10	ELUZIA F
	15313	3661925153133	E14	4	40	470	4 000	320	Non	80	Milky	35	113	1 10	ELUZIA F
	15314	3661925153140	E14	4	40	470	2 700	320	Non	80	Milky	35	113	2 10	ELUZIA F
	15315	3661925153157	E14	4	40	470	4 000	320	Non	80	Milky	35	113	2 10	ELUZIA F
TUBE															
	10578	3661925105781	E14	2	20	250	2 700	320	Non	80	Clair	25	80	1 10	ELUZIA E
CRAYON															
	16222	3661925162227	R7S	9	70	1 055	3 000	270	Non	LED	80	16	118	1 10	ELUZIA E
	16226	3661925162265	R7S	9	75	1 055	4 000	270	Non	LED	80	16	118	1 10	ELUZIA E

Évolution de l'efficacité des LED

Nombre de lumens produits par watt consommé (lm/W)

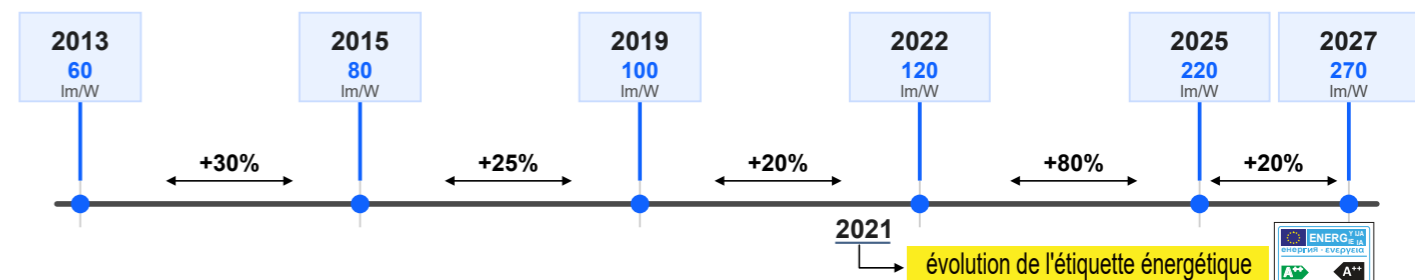

ELUZIA Classe énergétique **B** = -50% Économie d'énergie sur les LED 1ère génération

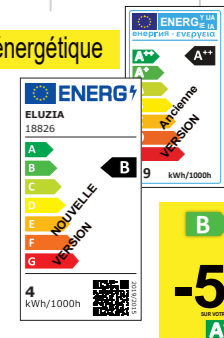

B d'aujourd'hui = -50% A+ d'hier

Avantages

- + Vos clients sont autonomes pour trouver la bonne ampoule.
- + Risque d'erreur réduit.
- + Ce qui se voit bien se vend plus.
- + Gain de productivité. Temps de recharge rapide et efficace.

Pour une mise en place structurée, nous vous proposons notre solution avec séparateur réversible, compatible poussoir à tabac.





SMD (Surface Mounting Device)

La LED SMD se distingue des LED de type COB (Chip On Board). C'est ce composant qui va définir la couleur obtenue. La couleur jaune est un substrat phosphorescent qui va diffuser la lumière.

Photo	Ref	Colot	Watts	W=	Lumen	°K	Angle	Varia.	IRC	Finit.	Ø (mm)	H (mm)	UVC	N.B.	TM	
A63 - STRONG																
	450071	5907178005293	E27	17	110	1700	4 000	180	Non	80	Opale	64	133	1	1	kob
GLOBE																
	10319	3661925103190	E27	15	100	1521	3 000	180	Non	80	Opale	120	162	1	4	ELUZIA
	10329	3661925103299	E27	15	100	1521	4 000	180	Non	80	Opale	120	162	1	4	ELUZIA
STANDARD																
	10336	3661925103367	E27	8,5	60	806	3 000	220	Non	80	Opale	60	108	1	10	ELUZIA
	10355	3661925103558	E27	15	100	1521	3 000	180	Non	80	Opale	70	128	1	10	ELUZIA
	10357	3661925103572	E27	15	100	1521	6 000	220	Non	80	Opale	70	128	1	6	ELUZIA
MINI SPHERIQUE																
	10321	3661925103213	E14	5	40	470	3 000	150	Non	80	Opale	45	78	1	10	ELUZIA
	10331	3661925103312	E14	5	40	470	6 000	220	Non	80	Opale	45	78	1	6	ELUZIA
FLAMME LISSE																
	450036	5900605097113	E14	4,5	28	420	6 000	200	Non	80	Opale	37	99	1	10	kob
	10020	3661925100205	E14	5	40	470	4 000	180	Non	80	Opale	37	107	1	10	ELUZIA
	10021	3661925100212	E14	5	40	470	3 000	180	Non	80	Opale	37	107	1	10	ELUZIA
	450039	5902846012979	E14	9	60	900	6 000	200	Non	80	Opale	37	106	1	10	kob
	450040	5900605094129	E27	6	40	470	3 000	200	Non	80	Opale	37	99	1	10	kob
	450041	5900605097533	E27	6	40	470	4 000	200	Non	80	Opale	37	99	1	10	kob
	450042	5900605095546	E27	6	40	470	6 000	200	Non	80	Opale	37	99	1	10	kob

Photo	Ref	Colot	Watts	W=	Lumen	°K	Angle	Varia.	IRC	Finit.	Ø (mm)	H (mm)	UVC	N.B.	TM	
SPOT R39																
	12009	3661925120098	E14	3	23	250	4 000	120	Non	90	Opale	39	67	1	10	ELUZIA
	12008	3661925120081	E14	3	23	340	3 000	120	Non	90	Opale	39	67	1	10	ELUZIA
SPOT R50																
	12001	3661925120012	E14	5	35	423	3 000	120	Non	90	Opale	50	83	1	10	ELUZIA
	12002	3661925120029	E14	5	35	423	4 000	120	Non	90	Opale	50	83	1	10	ELUZIA
	12012	3661925120128	E14	5	35	423	6 000	120	Non	90	Opale	50	83	1	6	ELUZIA
SPOT R60																
	12005	3661925120050	E27	8,5	60	725	3 000	120	Non	80	Opale	63	108	1	10	ELUZIA
	12006	3661925120067	E27	8,5	60	725	4 000	120	Non	90	Opale	63	108	1	10	ELUZIA
	12010	3661925120104	E27	8,5	60	725	6 000	120	Non	90	Opale	63	108	1	6	ELUZIA
SPOT R80																
	12011	3661925120111	E27	11	75	930	6 000	120	Non	90	Opale	80	110	1	6	ELUZIA
	12003	3661925120036	E27	11	75	950	3 000	120	Non	90	Opale	80	110	1	6	ELUZIA
	12007	3661925120074	E27	12	75	1200	4 000	120	Non	80	Opale	80	110	1	10	ELUZIA
PAR16																
	10708	3661925107082	GU10	7	40	560	3 000	100	Non	90	Clair	50	57	1	10	ELUZIA
	10709	3661925107099	GU10	7	40	560	4 000	100	Non	90	Clair	50	57	1	10	ELUZIA
	450030	5902846019121	GU10	7	70	615	6 500	100	Non	80	Blanc	50	55	1	10	kob
	450033	5902846011194	GU10	10	80	900	6 500	120	Non	80	Blanc	50	57	1	10	kob
MR16																
	10704	3661925107044	GU5,3	6	40	450	4 000	35	Non	80	Clair	50	52	1	10	ELUZIA
	10705	3661925107051	GU5,3	6	40	450	3 000	35	Non	80	Clair	50	50	1	10	ELUZIA
GX53																
	10385	3661925103855	GX53	5	40	470	4 000	300	Non	80	Opale	75	28	1	6	ELUZIA



Dorénavant tous nos emballages sont majoritairement en carton recyclable. Progressivement tous les blisters plastiques disparaissent au profit d'emballage en carton plus facilement recyclable. Pour gérer la transition, les blisters cartons peuvent indifféremment être positionné sur tablette ou sur broche. Les produits brochables sont identifiés par ce picto dans les tableaux de ce catalogue.

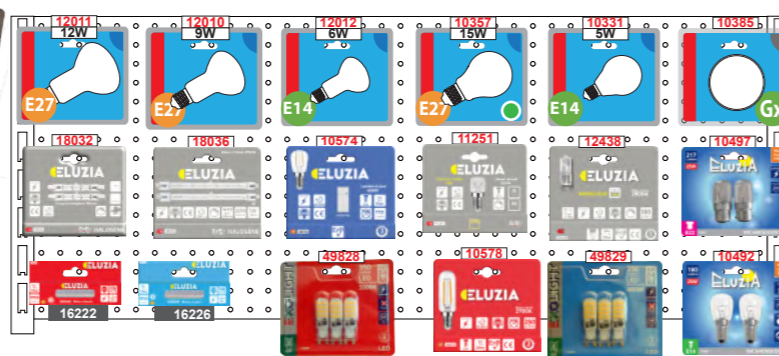

Évolution de l'étiquette label énergie :

9W +/-
806 lumen
=60W incandescent

A

Ce geste va vous faire économiser :

-50% minimum sur vos LED 1ère génération !

-90% minimum sur vos ampoules incandescentes !

Une marque taillée pour les prix discount

- ✓ Une gamme proposée exclusivement par lots
- ✓ Conçue pour vous positionner aux meilleurs prix
- ✓ Box promotionnel à votre disposition par quantité

AMPOULE LED SMD

Photo	Ref	Colut	Watts	W=	Lumen	°K	Angle	Varia.	IRC	Finit.	Ø (mm)	H (mm)	UVC	N.B.	TM	Gencod de l'unité	
STANDARD																	
	49840	B22	9	60	806	3 000	270	Non	80	Opale	60	110	☺	5	10	EXOLIGHT F	3661925199346
	49841	B22	9	60	806	4 000	220	Non	80	Opale	60	110	☺	5	10	EXOLIGHT F	3661925199346
	49818	E27	9	60	806	3 000	270	Non	80	Opale	60	108	☺	5	10	EXOLIGHT F	3661925498142
	49819	E27	9	60	806	4 000	270	Non	80	Opale	60	108	☺	5	10	EXOLIGHT F	3661925498159
MINI SPHERIQUE																	
	49929	E14	5	40	470	4 000	150	Non	80	Opale	45	80	☺	4	10	EXOLIGHT F	3661925199262
	49931	E14	5	40	470	3 000	150	Non	80	Opale	45	80	☺	4	10	EXOLIGHT F	3661925199315
FLAMME LISSE																	
	49843	E14	6	45	500	3 000	270	Non	80	Opale	37	100	☺	6	10	EXOLIGHT G	3661925498241
	49844	E14	6	45	500	4 000	270	Non	80	Opale	37	100	☺	6	10	EXOLIGHT G	3661925498258
SPOT R50																	
	49925	E14	5	40	420	4 000	180	Non	80	Opale	50	85	☺	4	10	EXOLIGHT G	3661925199254
	49930	E14	5	40	420	3 000	180	Non	80	Opale	50	85	☺	4	10	EXOLIGHT F	3661925199308
PAR16																	
	49826	GU10	6	40	500	3 000	100	Non	80	Opale	50	55	☺	4	10	EXOLIGHT G	3661925199261
CAPSULE																	
	49829	G9	4	40	350	4 000	330	Non	80	Clair	15	55	☺	3	10	EXOLIGHT F	-
	49830	G9	4	40	350	3 000	330	Non	80	Clair	15	55	☺	2	10	EXOLIGHT F	-

BOX CARTON



Vendu exclusivement par lot par Prodeal :



mais qui peut être "déloté" avec un gencod individuel



AMPOULE HALOGENE

Photo	Ref	Culot	Watts	W=	Lumen	°K	Angle	Varia.	Techno	IRC	Ø (mm)	L (mm)	UVC	N.B.	TM	
CRAYON																
	18032	3661925180320	R7S	120	150	2 216	2 700	320	Oui	Halo	100	10	78	Ⓜ	2 12	ELUZIA G
	18036	3661925180368	R7S	120	150	2 250	2 700	320	Oui	Halo	100	10	118	Ⓜ	2 12	ELUZIA G

AMPOULES FOUR

Photo	Ref	Culot	Volt.	Watts	°K	Angle	Varia.	Techno	IRC	Ø (mm)	H (mm)	°C	UVC	N.B.	TM	
POIRETTE																
	11251	3661925112512	E14	220	15	2 700	360	Oui	Incand.	100	22	45	300°	Ⓜ	1 10	ELUZIA G
CAPSULE																
	12438	3661925124386	G9	220	25	2 800	360	Oui	Incand.	100	14	46	300°	Ⓜ	1 10	ELUZIA G

AMPOULES FRIGO

Photo	Ref	Culot	Volt.	Watts	Angle	°K	Varia.	Techno	IRC	Ø (mm)	H (mm)	UVC	N.B.	TM	
POIRETTE															
	10574	3661925105743	E14	2	220	320	6 000	Non	LED	80	26	58	Ⓜ	1 10	ELUZIA F

AMPOULE GUIRLANDE

Photo	Ref	Culot	Watts	W=	Lumen	°K	Angle	Varia.	IRC	Finit.	Ø (mm)	H (mm)	UVC	N.B.	TM
MINI SPHERIQUE															
	47606	3661925476065	E27	1	-	Rouge	320	Non	80		45	79	Ⓜ	10 10	ELUZIA G
	47607	3661925476072	E27	1	-	Jaune	320	Non	80		45	79	Ⓜ	10 10	ELUZIA G
	47608	3661925476089	E27	1	-	Bleu	320	Non	80		45	79	Ⓜ	10 10	ELUZIA G
	47609	3661925476096	E27	1	-	Vert	320	Non	80		45	79	Ⓜ	10 10	ELUZIA G
	47616	3661925476164	E27	1	-	Rouge	320	Non	80		45	79	Ⓜ	1 10	ELUZIA G
	47617	3661925476171	E27	1	-	Jaune	320	Non	80		45	79	Ⓜ	1 10	ELUZIA G
	47618	3661925476188	E27	1	-	Bleu	320	Non	80		45	79	Ⓜ	1 10	ELUZIA G
	47619	3661925476195	E27	1	-	Vert	320	Non	80		45	79	Ⓜ	1 10	ELUZIA G

AMPOULE IODURE

Photo	Ref	Culot	Volt.	Watts	Angle	°K	Varia.	Techno	IRC	Ø (mm)	H (mm)	UVC	N.B.	TM	
TUBULAIRE															
	19830	3662094200802	E40	500	220	320	2 700	Oui	Halo	100	38	225	Ⓜ	1 1	x G
	19831	3662094200819	E40	1 000	220	320	2 700	Oui	Halo	100	38	260	Ⓜ	1 1	x G

AMPOULE INCANDESCENTE

Photo	Ref	Culot	Volt.	Watts	Angle	°K	Varia.	Techno	IRC	Ø (mm)	H (mm)	UVC	N.B.	TM	
TUBE															
	10492	3661925104920	E14	25	220	320	2 700	Oui		100	28	80	Ⓜ	2 10	ELUZIA G
TUBULAIRE															
	10497	3661925104975	B22	25	220	320	2 700	Oui		100	28	80	Ⓜ	2 10	ELUZIA G

TUBE LED EN VERRE



Les tubes en verre sont une solution grand public. Pour un usage intensif et pour les opérations dit de « relamping », il faudra privilégier un tube avec refroidisseur en Alimuniun de la gamme Maltis.

STARTER SHUNTER

Les starters « shunter » sont fournis de série avec nos tubes

Ils s'utilisent avec une réglette de type ferro-magnétique.

Ce starter permet de convertir une réglette fluoescence en réglette LED (ne fonctionne pas pour les modèles équipés d'un ballast électronique, mais uniquement des modèles avec ballast ferromagnétique).

N.B. : Veuillez à ne pas confondre les 2 types de starters, ils ne sont pas compatibles.

NEW

Nouveau conditionnement

Photo	Ref	Culot	Watts	Techno	Lumen	°K	Ø (mm)	Angle	Varia.	IRC	Finit.	Défect	UVC	N.B.	TM
T8 0M60															
	10627	3661925106276	G13	9	LED	900	4 000	26	220	Non	80	Opale	Ⓜ	1 6	ELUZIA E
T8 0M90															
	10611	3661925106115	G13	14	LED	1 200	4 000	13	270	Non	80	Opale	Ⓜ	1 25	x MALTIS F
T8 1M20															
	16673	3661925166737	G13	18	LED	2 340	4 000	26	200	Non	80	Opale	Ⓜ	1 16	ELUZIA E
T8 1M50															
	16623	3661925166232	G13	22	LED	2 860	4 000	26	200	Non	80	Opale	Ⓜ	1 16	ELUZIA E

STARTER SHUNTER

Photo	Ref	Techno	UVC	N.B.	TM
STARTER					
	10647	3661925106474	LED	-	Ⓜ 1 10 ELUZIA
	10648	3661925106481	LED	-	Ⓜ 4 4 ELUZIA

Ne pas utiliser le starter shunter avec une réglette équipée de tubes fluorescent.

Compatibles avec les réglettes équipées de ballast ferromagnétique (présence d'un starter).

T8 0M90

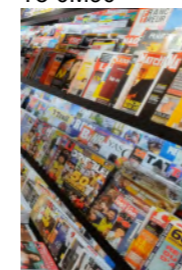

Pour éclairer les gondoles de 1m type Maiso.de la presse

T8 0M60

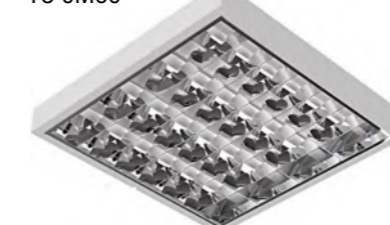

Pour remplacer les tubes fluo d'un luminaire composé de 4 tubes, le starter shunter ne conviendra pas. Il faudra modifier le cablage du luminaire. De même pour une réglette composée de 2 tubes de 60 cm, car le luminaire utilise 1 driver qui pilote 2 tubes. Flashez le QR code pour en savoir plus.

Privilégiez l'utilisation d'un panel LED, qui sera plus performant.

Règles de montage





DOWNLIGHT

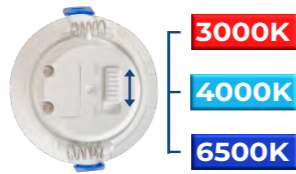

Photo	Ref	Watts	Lumen	°K	Angle Varia.	Ø (mm)	H (mm)	IP	Finit.	UVC	N.B.	TM
3000 - 4000 - 6500 K												
49715	3661925497152	7	650-735	CCT	38°	Non	85	40	IP40	70	Blanc	ELUZIA

DOWN LIGHT ENCASTRE

Photo	Ref	Forme	Ø (mm)	Øcut	Mat.	Fonct.	IP	Finit.	Model	Type	UVC	N.B.	TM
Basculant													
14105	5906340210930	Rond	96	85/90	Acier		IP20			Rondelle	1	10	kob
14206	5906340214365	Rond	93	75/85	Acier		IP20			Rondelle	1	10	kob
14207	5906340214334	Rond	93	75/85	Acier		IP20	Graphite		Rondelle	1	10	kob
14208	5900605093382	Rond	84	78/80	Acier		IP20			Rondelle	1	10	kob
14104	5906340210947	Rond	96	85/90	Acier		IP20	Blanc		Rondelle	1	10	kob
Fixe													
14103	5906340210862	Rond	82	60/75	Acier	Fixe	IP20	Brossé	OH14	Rondelle	1	10	kob
14102	5906340210879	Rond	82	60/75	Acier	Fixe	IP20	Blanc	OH14	Rondelle	1	10	kob
14403	5900605098882	Carré	150	153	Plâtre	Fixe	IP20	Blanc		Rondelle	1	1	kob
14118	5900605093634	Carré	96	60/70	Acier	Fixe	IP20	Noir		Rondelle	1	10	kob
14107	5900605096734	Rond	83	78	Acier	Fixe	IP44	Brossé		Rondelle	1	6	kob
14106	5900605097786	Rond	83	78	Acier	Fixe	IP44	Blanc		Rondelle	1	6	kob
14130	5902201305470	Rond	83	78	Acier	Fixe	IP44	Noir		Rondelle	1	6	kob

Photo	Ref	Culot	UVC	N.B.	TM
DOUILLE					
Douille					
14100	3661925141000	GU10	1	6	ELUZIA
14101	3661925141017	GU5,3	1	5	ELUZIA

Photo	Ref	TechnoWatts	Lumen	°K	Finit.	H (mm)	L (mm)	I (mm)	IP	UVC	N.B.	TM
PROJECTEUR DE SOL												
14451	5900605095522	-	LED 50 Max	-						1	1	kob

Photo	Ref	Watts	Lumen	Varia.	Angle	°K	Délect	Ø (mm)	L (mm)	I (mm)	H (mm)	IP	Form	UVC	N.B.	TM
PROJECTEUR DE SOL																
Ovale																
16507	3661925165075		1 050	Non	120	4 000	Non	105	210	48	IP54			1	10	ELUZIA
Rond																
10506	3661925105064	12	840	Non	120	4 000	Non	210		82	IP54			1	10	ELUZIA



Rationaliser vos stocks !
 Ne jetez plus un projecteur pour un détecteur en panne
 100 lumens/watt (contre 80 lumens habituellement)

Réglage par télécommande

série "STARLINE" ★★★★★

Garantie 3 ans

Photo	Ref	TechnoWatts	Lumen	Finit.	°K	H (mm)	L (mm)	I (mm)	IP	Délect.	Poids (kg)	UVC	N.B.	TM	
STARLINE															
16730	3661925167307	LED	10	1 000	Noir	4 000	26	104	104	IP65	Option	0,2	1	1	ELUZIA
16735	3661925167352	LED	30	3 000	Noir	4 000	30	136	188	IP65	Option	0,5	1	1	ELUZIA
16740	3661925167406	LED	50	5 000	Noir	4 000	32	160	221	IP65	Option	0,7	1	1	ELUZIA
16745	3661925167451	LED	100	10 000	Noir	4 000	33	226	242	IP65	Option	1,5	1	1	ELUZIA

DÉTECTEUR "PLUGABLE"														
16729	3661925167291	Infra rou		Noir					IP54			1	1	ELUZIA



CCT

3000K
4000K
6500K

Puissance gradable

Infra rouge

Batterie

Transition Elu 10 vers Starline

Photo	Ref	Watts	Lumen	°K	Finit.	H (mm)	L (mm)	I (mm)	IP	Délect	Batterie	Ampèr.	UVC	N.B.	TM
PROJECTEUR SOLAIRE															
10750	3661925107501	6		CCT	Noir	44	97	143	IP65	Oui	Amovible	2,2	1	4	ELUZIA
10751	3661925107518	8		CCT	Noir	44	97	194	IP65	Oui	Amovible	2,6	1	1	ELUZIA

Photo	Ref	Fonct.	Angle	Finit.	IP	H (mm)	L (mm)	I (mm)	Techno	UVC	N.B.	TM
DETECTEUR												
Présence												
10571	5906340218301	Présence	180	Noir	IP54	83	95	86	IR	1	6	kob
20104	5900605092347	Présence	180	Blanc	IP20	37,2	54,5	39,4	HF	1	1	kob
22292	5906340219285	Présence	180	Blanc	IP54	83	95	86	IR	1	6	kob

Photo	Ref	UVC	N.B.	TM	
ACCESSOIRES PROJECTEURS					
Piquet					
80001	3661925800013	Jusque 1,5 kg de charge	1	1	MALLTS
Potence					
80007	3760349200864	Jusque 2 kg de charge	1	1	MALLTS



REGLETTE

Photo	Ref	Watts	Techno	Culot	Tube	°K	Lumen	L (mm)	I (mm)	H (mm)	IP	Délect.	UVC	N.B.	TM
SNAKE															
	13385	3661925133852	18	LED	- Intégré		1 750	1230	53	35	IP65	Non	Ⓟ	1 20	ELUZIA
	13386	3661925133869	24	LED	- Intégré		2 300	1510	53	35	IP65	Non	Ⓟ	1 20	ELUZIA

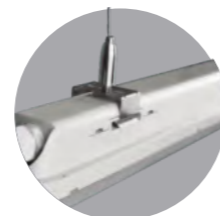
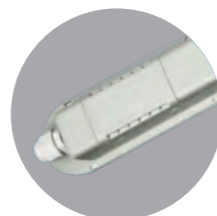
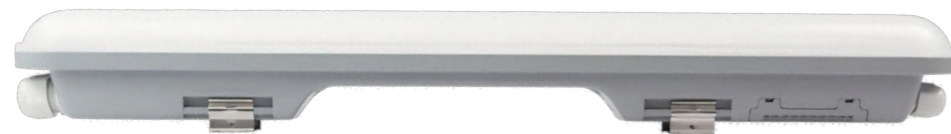

REGLETTE

Photo	Ref	Watts	Techno	Culot	Tube	°K	Lumen	L (mm)	I (mm)	H (mm)	IP	Délect.	UVC	N.B.	TM	
LED INTEGREE																
	13880	3661925138802	18	LED	-	14	4 000	1 800	1 150	58	58	IP65	Non	Ⓟ	1 12	ELUZIA
	13881	3661925138819	36	LED	-	12	4 000	3 600	1 150	78	58	IP65	Non	Ⓟ	1 8	ELUZIA
	13882	3661925138826	24	LED	-	10	4 000	2 400	1 450	58	58	IP65	Non	Ⓟ	1 12	ELUZIA
	13883	3661925138833	48	LED	-	9	4 000	4 800	1 450	78	58	IP65	Non	Ⓟ	1 8	ELUZIA

Photo	Ref	Watts	Techno	Culot	Tube	°K	Lumen	L (mm)	I (mm)	H (mm)	IP	Délect.	UVC	N.B.	TM	
Avec TUBE T8																
	13972	3661925139724	36	LED	G13	2x18W	4 000	3150	1284	96	60	IP65	Non	Ⓟ	1 12	ELUZIA
	13973	3661925139731	48	LED	G13	2x24W	4 000	4200	1584	96	60	IP65	Non	Ⓟ	1 12	ELUZIA
	13970	3661925139700	18	LED	G13	1x18W	4 000	1620	1 284	62	60	IP65	Non	Ⓟ	1 12	ELUZIA
	13971	3661925139717	24	LED	G13	1x24W	4 000	2160	1 584	96	60	IP65	Non	Ⓟ	1 8	ELUZIA
SANS TUBE																
	601732	5900605099384		LED	G13	option		600	68	58	IP65		Ⓟ	1 1		kobi



PANEL BACKLIGHT

Photo	Ref	Forme	Conso	Type	Lumen	°K	L (mm)	I (mm)	H (mm)	IP	UGR	UVC	N.B.	TM
60x60														
	42283	3661925422833	60x60	40 Backlite	4 000	4 000	595	595	10	IP40	<19	Ⓟ	1 8	ELUZIA
	42284	3661925422840	60x60	40 Backlite	4 000	5 000	595	595	10	IP40	<19	Ⓟ	1 8	ELUZIA

ACCESSOIRES PANEL BACKLITE

Photo	Ref	Forme	Finit.	I (mm)	L (mm)	H (mm)	Gamme	UVC	N.B.	TM
60x60										
	40975	3661925409759	60x60	Blanc	602	602	70	Ⓟ	1 1	MALITIS

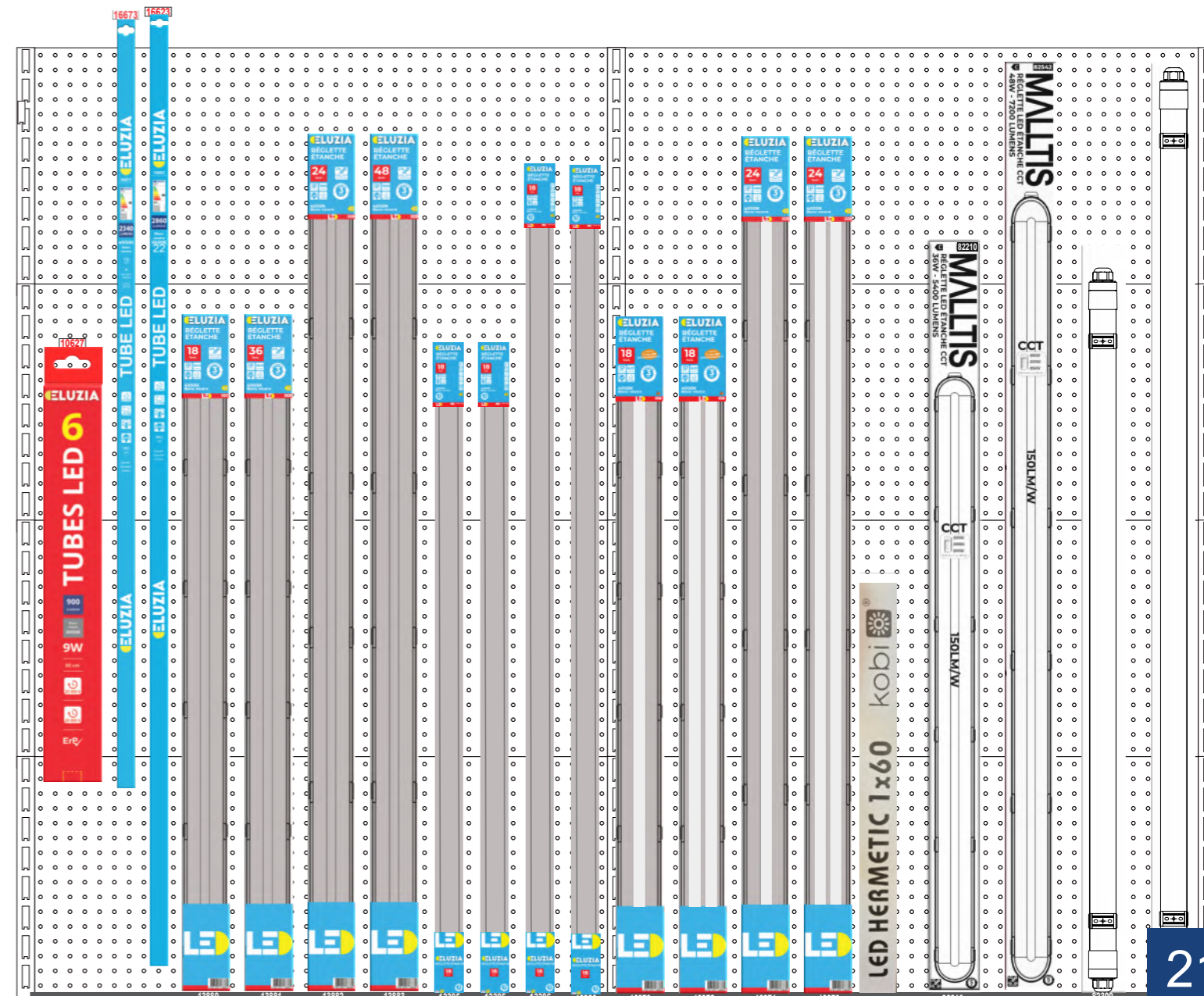



CCT



Indice de protection IP65



Connectable



150LM/W



Maintenance facile

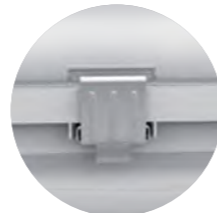

Clips inox

REGLETTE

Photo	Ref	Watts	Techno	Culot	°K	Lumen)	L (mm)	I (mm)	H (mm)	IP	Délect.	UVC	N.B.	TM
MALLTIS														
	82210	36	LED	-	41	CCT	5 400	1 205	79	68	IP65	Non	1 12	MALLTIS
	82542	48	LED	-	9	CCT	7 200	1 499	79	68	IP65	Non	1 9	MALLTIS

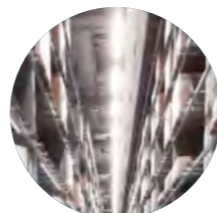

Photo	Ref	Watts	Techno	Culot	Tube	°K	Lumen)	L (mm)	I (mm)	H (mm)	IP	Délect.	UVC	N.B.	TM
U-LINE															
	82300	36	LED	-	Intégré	CCT	4 320	1 572	47,5	59,5	IP65	Non	1 15	MALLTIS	
	82305	50	LED	-	Intégré	CCT	6 000	1 572	47,5	59,5	IP65	Non	1 12	MALLTIS	



Haute efficacité
150 LM/W

9 en 1

Angles



Watts

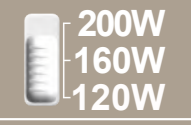

Kelvin

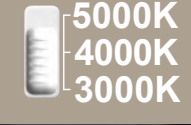

Photo	Ref	Fonct.	Angle	Finit.	IP	H (mm)	L (mm)	I (mm)	Techno	NF	Pile	UVC	N.B.	TM
HIGH BAY														
	81410		120						CCT		IP65	1 4	Ñ	MALLTIS
ACCESSOIRES ZHAGA														
	81505	Détecteur infra rouge										1 1		MALLTIS
	81507	Télécommande										1 1		MALLTIS
CHAINE														
	81506											1 1	Ñ	MALLTIS



Garantie



IP65



IK10



50 000h



-30°C~+45°C



Forte dissipation de chaleur



Installation rapide



PANEL UGR<19

PANEL BACKLIGHT

Photo	Ref	Forme	Conso	Type	Lumen	°K	L (mm)	I (mm)	H (mm)	IP	UGR	UVC	N.B.	TM
60x60														
	31030	3661925310307	60x60	26W	3 600	4 000	595	595	32	IP40	<19	1	5	MALLTIS

ACCESSOIRES PANEL BACKLIT

Photo	Ref	Forme	Finit.	I (mm)	L (mm)	H (mm)	Gamme	UVC	N.B.	TM
60x60										
	40975	3661925409759	60x60	Blanc	602	602	70	1	1	MALLTIS

Diffuseur en PMMA

Ce qui fait la qualité du panel, c'est son diffuseur. Ce matériaux permet une qualité de diffusion optimale pour un meilleur rendement et également dispose d'un traitement pour éviter de jaunir avec le temps.



INSTALLATION & ACCESSOIRES



UGR<19

Les initiales UGR signifient « Unified Glare Rating ».

C'est l'indice du niveau d'éblouissement du luminaire. La norme EN 12464-1 pour les lieux de travail

La norme EN 124654-1 définit les valeurs UGR maximum pour les différentes zones de l'espace de travail.

Pour l'éclairage des bureaux tertiaires, la norme impose une valeur UGR <19.

Haute efficacité
120 LM/W

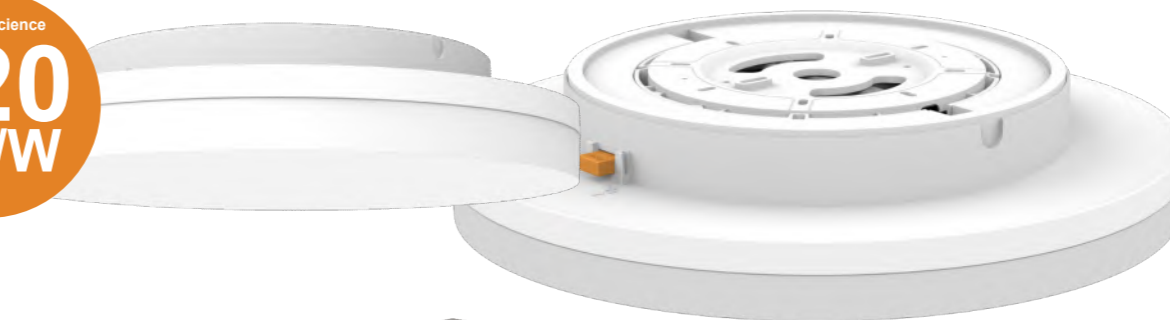

10 références en 1!

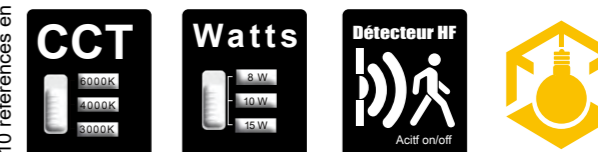
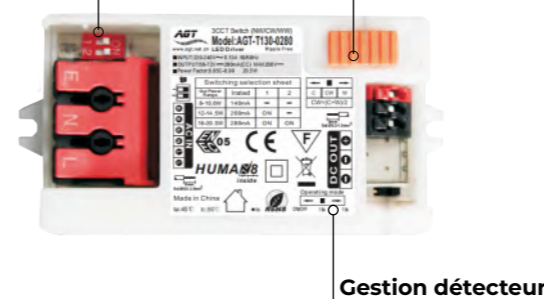

Photo	Ref	Watts	Lumen	Varia.	Angle	°K	Délect	Ø (mm)	L (mm)	I (mm)	H (mm)	IP	Forme	VC	N.B.	TM
	31013	3661925310130	15	1800	Non	120	CCT	Oui	260		57	IP54	1	1	MALLTIS	

Sélection de puissance

Sélection couleur (3/4/6K)



Interrupteur poussoir

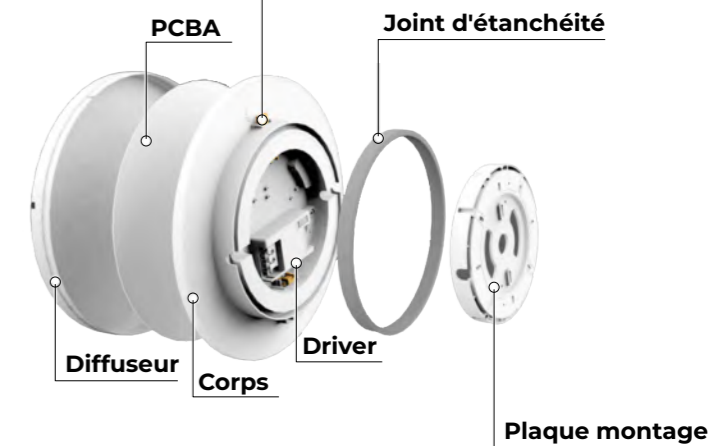

Vidéo de présentation





TECHNOLOGIE SMD



IP65 TECHNOLOGIE COB



RUBAN 220V

Photo	Ref	V	IP	W/m	°K	Lm/W	l (mm)	L (mm)	IRC	Angle	UVC	N.B.	TM
SMD													
	20000	366192520000	220	IP65	5 000	114	20	Non	80	120	⊕	1 2	ELUZIA F
	20001	366192520001	220	IP65	5 000	100	20	Oui	80	120	⊕	1 2	ELUZIA F
	20002	366192520002	220	IP65	5 000	100	20	Oui	80	120	⊕	1 3	ELUZIA F
COB													
	20003	366192520003	220	IP65	5 000	100	20	Oui	80	120	⊕	1 2	ELUZIA F
	20004	366192520004	220	IP65	5 000	90	20	Oui	90	120	⊕	1 3	ELUZIA F

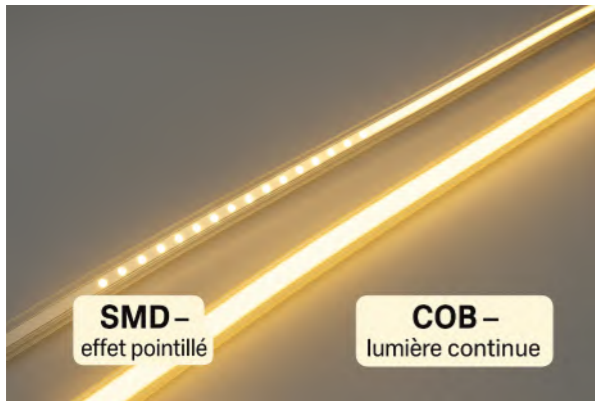

Pour un travail de précision la technologie COB est la solution idéale.



PROJECTEUR DE CHANTIER

Photo	Ref	IP	Watts	Varia.	l (mm)	L (mm)	H (mm)	Volt.	PF	A	UVC	N.B.	TM	
ELUZIA														
	22655	366192522655	LED	50	4 200	25 m	310	80	320	80	IP54	3 m	80	⊕ 1 4 ✖ ELUZIA G
	22656	366192522656	LED	2x30	5 650	20 m	280	190	220	190	IP65	3 m	80	⊕ 1 4 ✖ ELUZIA F
	22687	366192522687	LED	50	6 500		5 000				IP65			⊕ 1 1 ✖ ELUZIA
	22682	366192522682	LED	100	11500		5 000	545	465	442	IP54			⊕ 1 1 ✖ ELUZIA D



PROJECTEUR SUR TREPIED

Photo	Ref	Techno	Watts	Lumen	°K	Portée	H (mm)	l (mm)	L (mm)	IP	L.cable	IRC	UVC	N.B.	TM
	22658	366192522658	LED	50	4 200	5 000	25 m	1600	250	250	IP54	3 m	⊕	1 1 ✖	ELUZIA G
	22657	366192522657	LED	2x50	8 400	5 000	25 m	1600	102	27,5	IP54	3 m	⊕	1 1 ✖	ELUZIA G

TREPIED

Photo	Ref	Mat	H	Fini	H maxi	UVC	N.B.	TM
	22389	366192522389	Alumini			⊕	1 1 ✖	ELUZIA
	22701	366192522701	Acier			⊕	1 1 ✖	ELUZIA



GARANTIE 5 ANS



adaptateurs inclus pour :

18V



Batterie



Photos indicatives et non contractuelles

La compatibilité est liée à une génération de batteries. La technologie des batteries évoluant régulièrement, vérifiez avant votre achat la compatibilité de votre batterie avec ce projecteur.

Photo	Ref	IP	Watts	Varia.	I (mm)	L (mm)	H (mm)	Volt.	PF	A	UVC	N.B.	TM
Projecteurs hybride													
	22685	366192522685	LED								IP65	1	1
	22681	366192522681	LED	65	6500	5 000	532	350	345	IP65	1	4	
Projecteurs hybride													
	22683	366192522683	Einhel									1	1



- Aimants
- Prise type C
- Anneau ceinture
- Béquille 90°



Réf. 22675

10W

- LED COB
- 1 000 Lumens
- Pile Lithium 3,7V/2,2Ah
- Tension d'entrée DC 5V,1A
- Indice de protection IP54
- Autonomie : +/- 2 heures
- Réglage de la puissance : 100% - 50% - 25%



Réf. 30801

12W

- Jusqu'à 1 600 Lumens
- Angle de diffusion 120°
- Gradation 3 positions
- Poignée ergonomique
- 6 points de fixation
- Aimant forte intensité
- IP 67 étanche
- Autonomie jusqu'à 8 h



Réf. 30825

12W

- 3 puissances disponibles
- Fonction clignotant rouge
- 100 000 cycles d'allumage
- Alimentation par USB
- 6 000 K
- Corps ABS
- Dragonne incluse



Réf. : 600011

3W

- 2 puissances
- Li-ion 18650mAh
- 3,7 V
- 6 500K
- 60/150 Lumen
- Corps en TPR
- 155/40/20mm



Réf. : 600012

5W

- 2 puissances
- Li-ion 18650mAh
- 3,7 V
- 6 500K
- 360 Lux
- PC + TPR + Aluminium
- 150/48/39mm



Réf. : 600013

360 Lux

- 2 puissances
- Li-ion 18650mAh
- 3,7 V
- 6 500K
- 360 Lux
- PC + TPR + Aluminium
- 150/36/31mm

LED RAYON



Pour valoriser vos linéaires, nous vous proposons la solution d'éclairage LED Rayon qui illumine et magnifie vos articles.



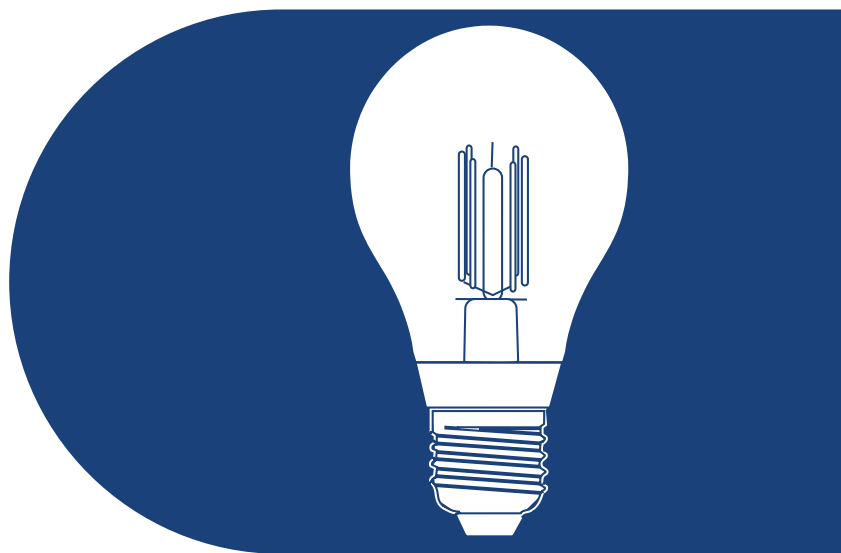

Siège social et Logistique :
ZI de Grâces
11 route de Kerbost
22200 GUINGAMP - France

+33 2 96 14 02 05
info@groupe-prodeal.com

SAS au capital de 300 003 €
Siret 751892274 - APE 4690Z
RCS SAINT-BRIEUC B 751 892 274
N° TVA intracommunautaire FR 34751892274

groupe-prodeal.com