

ELUZIA LED



GROUPE **pro**
deal

L'éclairage constructif

2026

MALLTIS

PRÉSENTATION

Depuis de nombreuses années, le groupe PRODEAL propose des solutions d'éclairage grand public et professionnelles.

PRODEAL s'est doté de capacité d'ingénierie capable de superviser la qualité de ses approvisionnements, de concevoir des solutions à la demande et d'entrer dans l'ère du tout connecté.

Toujours plus pointu et plus exigeant, PRODEAL évolue et se développe depuis plusieurs années avec de nouveaux partenariats commerciaux et techniques pour accélérer sa croissance.

PRODEAL, c'est votre expert éclairage, votre spécialiste de la lumière centré sur une compétence unique. L'architecte de vos linéaires d'ampoules pour les revendeurs, le concepteur/designer de l'éclairage pour les installateurs.

NOS MARQUES

Parce que les besoins des clients sont multiples, nous avons segmenté nos marques commerciales

Occuper tous les segments du marché, c'est répondre aux attentes des différents consommateurs en offrant un choix de produits variés.

MALLTIS

Notre marque PRO

C'est le choix de la performance, avec des produits atteignant 200 lumens/watt consommé par exemple. Une garantie de 5 ans en moyenne et une gamme modulable et conçue sur mesure.

ELUZIA

Notre marque grand public et semi-pro

Positionnement généraliste, Eluzia propose les 20/80, mais aussi une large gamme de classe B en verre claire et Milky, pour un prix proche des SMD de classe E ou F.

plus grand nombre.

EXOLIGHT

Notre gamme discount

Gamme courte, composée de lots, avec la vocation d'être vos produits d'appel et de promotion et ainsi d'épargner votre fonds de rayon.



Picto qui indique des fonctions polyvalente pour rationaliser vos stocks

RELAMPING

Nos experts PRODEAL vous accompagnent pour l'éclairage de vos parkings, de vos magasins, entrepôts et bureaux.



Nous vous proposons également une solution exclusive d'éclairage de gondole s'adaptant à tous les mobiliers existants.

Pour faciliter vos choix et vous aider à vous projeter, nous réalisons des études d'éclairage déterminant l'éclairage optimal pour vos locaux, bureaux, surfaces commerciales ainsi que vos espaces extérieurs.

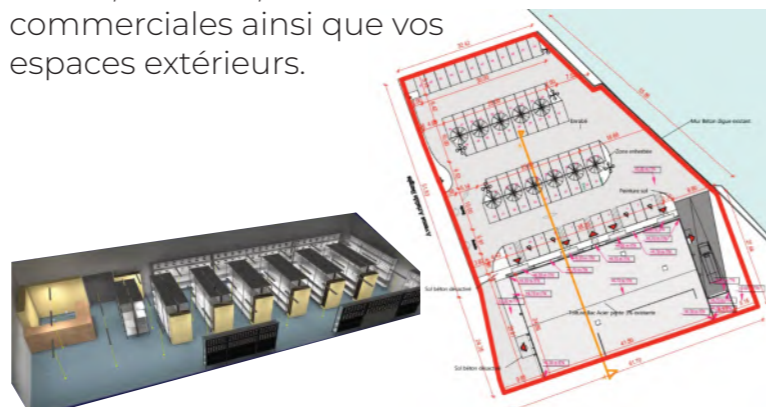

BUREAU D'ÉTUDE

Un bureau d'études, toujours à l'écoute de nos clients et de leurs besoins les plus pointus, PRODEAL a su innover en développant de nombreuses gammes.

Ce sont aussi des choix techniques originaux et de confort qui permettent de se démarquer résolument.

La qualité est au cœur de notre approche, tous nos produits bénéficient d'un ERP, gage d'une conception haut de gamme et sans concession à la fiabilité.

l'ERP, c'est 6 000 heures de test en continu, avec 80 % du flux lumineux minimum restitué au terme de ce délai (directive EN 1194/2011)

SOMMAIRE

Page	Rubrique
04	Ampoules MALLTIS
06	PAR16 & LINOLITE
08	Ampoules LED FILAMENT ELUZIA
12	Ampoules LED SMD ELUZIA
14	Ampoules EXOLIGHT
16	Ampoules spéciales
17	Tubes LED
18	Luminaires
19	Projecteurs
20	Réglettes étanches ELUZIA
21	Panel Eluzia
22	Réglettes étanches Malttis
23	High Bay Malttis
24	Panel Malttis
25	Hublot anti-vandal
26	Rouleaux LED
27	Projecteurs de chantier
28	Projecteurs hybride
29	Eclairage sur batterie

PICTOS

- Fourreau brochable
- Emballage brochable
- Blister
- Emballage boîte carton non brochable
- Emballage boîte carton brochable
- Nouveauté
- Jusqu'à épuisement des stocks
- Prochainement
- Indice de rendu des couleurs



AMPOULE LED FILAMENT

Ref		Culot	Watts	W=	Lumen	°K	Angle	☑	IRC	Finit.	Ø (mm)	H (mm)	UVC	☑	N.B.	TM	
GLOBE																	
15930	3661925159302	E27	4	25	250	2 200	320	Oui	90	Clair	80	120	☑	1	2	MALLTIS	G
15901	3661925159012	E27	8	60	800	2 200	360	Non	80	Ambré	95	135	☑	1	2	MALLTIS	F
ST64																	
15900	3661925159005	E27	6	51	600	2 200	320	Non	80	Ambré	64	146	☑	1	2	MALLTIS	F
STANDARD																	
15987	3661925159876	B22	7	50	770	3 000	320	Oui	90	Clair	60	110	☑	1	6	MALLTIS	E
15988	3661925159883	B22	7	50	770	4 000	320	Oui	90	Clair	60	110	☑	1	6	MALLTIS	E
15992	3661925159920	B22	3,8	60	806	3 000	320	Non	80	Clair	60	105	☑	1	10	MALLTIS	A
15993	3661925159937	B22	3,8	60	806	4 000	320	Non	80	Clair	60	105	☑	1	10	MALLTIS	A
15996	3661925159968	B22	7	100	1 521	3 000	320	Non	80	Clair	60	105	☑	1	10	MALLTIS	A
15997	3661925159975	B22	7	100	1 521	4 000	320	Non	80	Clair	60	105	☑	1	10	MALLTIS	A
15933	3661925159333	E27	3	15	150	2 200	320	Oui	90	Clair	60	100	☑	1	6	MALLTIS	G
15934	3661925159340	E27	7	55	770	3 000	320	Oui	90	Clair	60	100	☑	1	10	MALLTIS	E
15935	3661925159357	E27	7	55	770	4 000	320	Oui	90	Clair	60	100	☑	1	10	MALLTIS	E
15990	3661925159906	E27	3,8	60	806	3 000	320	Non	80	Clair	60	105	☑	1	10	MALLTIS	A
15991	3661925159913	E27	3,8	60	806	4 000	320	Non	80	Clair	60	105	☑	1	10	MALLTIS	A
15994	3661925159944	E27	7	100	1 521	3 000	320	Non	80	Clair	60	105	☑	1	10	MALLTIS	A
15995	3661925159951	E27	7	100	1 521	4 000	320	Non	80	Clair	60	105	☑	1	10	MALLTIS	A
MINI SPHERIQUE																	
15047	3661925150477	B22	2,5	20	250	2 700	320	Non	80	Clair	45	72	☑	1	10	MALLTIS	F
15051	3661925150514	B22	4	40	400	2 700	320	Non	80	Clair	45	74	☑	1	10	MALLTIS	F
15936	3661925159364	E27	2	15	100	2 200	320	Oui	90	Clair	45	74	☑	1	6	MALLTIS	G
15046	3661925150460	E27	2,5	20	250	2 700	320	Non	80	Clair	45	74	☑	1	10	MALLTIS	F
15048	3661925150484	E27	4	40	400	2 700	320	Non	80	Clair	45	74	☑	1	10	MALLTIS	F
15937	3661925159371	E27	5	35	400	3 000	320	Oui	90	Clair	45	74	☑	1	6	MALLTIS	G
15938	3661925159388	E27	5	35	400	2 200	320	Oui	90	Clair	45	74	☑	1	6	MALLTIS	G
SPOT R60																	
15049	3661925150491	E27	2	20	200	2 700	180	Non	80	Clair	63	105	☑	1	10	MALLTIS	F

Avantage du verre dépolie extérieur :
pas de reflet aspect authentique



Ref		Culot	Watts	W=	Lumen	°K	Angle	☑	IRC	Finit.	Ø (mm)	H (mm)	UVC	☑	N.B.	TM	
FLAMME LISSE																	
15931	3661925159319	E14	2	15	100	2 200	320	Oui	90	Clair	36	110	☑	1	6	MALLTIS	G
15932	3661925159326	E14	4	35	380	4 000	320	Oui	90	Clair	36	100	☑	1	6	MALLTIS	F
16302	3661925163026	E14	5	40	450	2 700	320	Non	90	Dépoli	35	100	☑	1	6	MALLTIS	E
FLAMME TORSADÉE																	
16308	3661925163088	E14	7	60	400	2 700	320	Oui	90	Dépoli	35	100	☑	1	6	MALLTIS	E
16300	3661925163002	E14	4	40	450	2 700	320	Non	90	Dépoli	50	140	☑	1	6	MALLTIS	E
16309	3661925163095	E14	7	60	806	2 700	320	Oui	90	Dépoli	35	100	☑	1	6	MALLTIS	E
16301	3661925163019	B22	4	40	450	2 700	320	Non	90	Dépoli	50	140	☑	1	6	MALLTIS	E
16305	3661925163057	E27	4	40	400	2 700	320	Non	90	Dépoli	50	140	☑	1	6	MALLTIS	E
FLAMME COUP DE VENT																	
15902	3661925159029	E14	4	35	400	2 200	360	Non	80	Ambré	35	113	☑	1	6	MALLTIS	F
16304	3661925163040	E14	4	40	450	2 700	320	Non	90	Dépoli	35	125	☑	1	6	MALLTIS	E
FLAMME CDV DROITE																	
16291	3661925162913	E14	4	25	265	2 700	320	Oui	90	Dépoli	22	89	☑	1	6	MALLTIS	F
16290	3661925162906	E14	1	10	90	2 700	320	Oui	90	Dépoli	22	89	☑	1	6	MALLTIS	F
16303	3661925163033	E14	2	25	230	2 700	320	Non	90	Dépoli	35	125	☑	1	6	MALLTIS	E
16292	3661925162920	E14	4	25	300	2 700	320	Oui	90	Dépoli	35	125	☑	1	6	MALLTIS	F

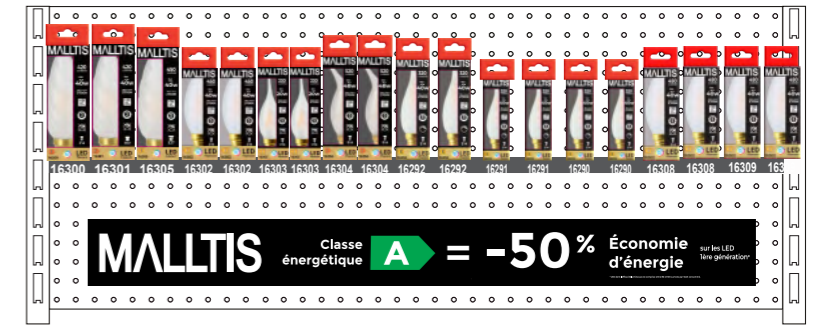
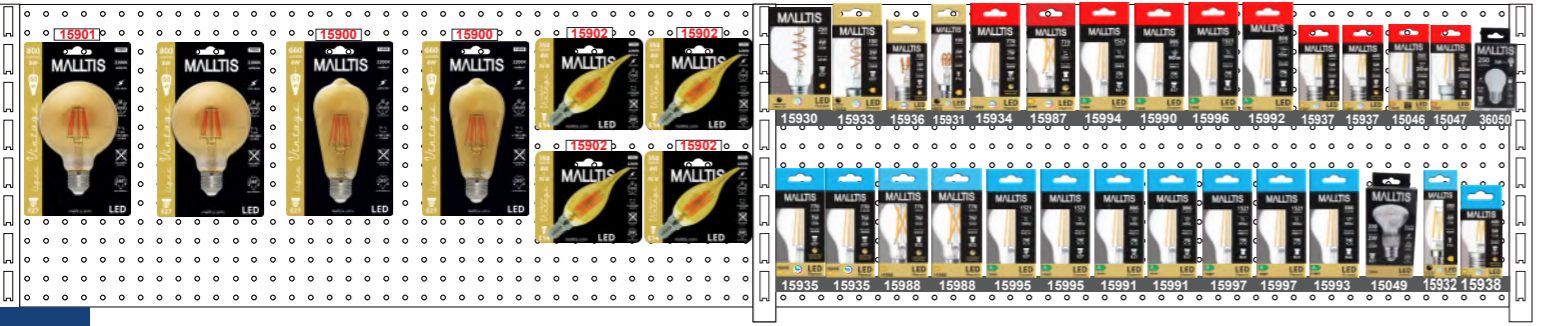

PAR 16



LINOLITE



AMPOULE LED SMD

Ref	Barcode	Culot	Watts	W=	Lumen	°K	Angle	Beam	IRC	Finit.	Ø (mm)	H (mm)	UVC	Recycle	N.B.	TM
SPORT PAR16																
15939	3661925159395	GU10	5,5	40	420	2 700	36	Oui	95	Opale	50	55	⊕	1	10	MALLTIS
15940	3661925159401	GU10	5,5	40	420	4 000	36	Oui	95	Opale	50	55	⊕	1	10	MALLTIS
15941	3661925159418	GU10	5,5	40	420	5 000	36	Oui	95	Opale	50	55	⊕	1	10	MALLTIS

TUBE LINOLITE S19

Ref	Barcode	Culot	Watts	W=	Lumen	°K	Angle	Beam	IRC	Finit.	Ø (mm)	H (mm)	UVC	Recycle	N.B.	TM
LINOLITE																
11223	3661925112239	S19	9	60	806	3 000	180	Non	90	Opale	38	309	⊕	1	10	MALLTIS
11224	3661925112246	S19	9	60	806	4 000	180	Non	90	Opale	38	309	⊕	1	10	MALLTIS

L'IRC (Indice de Rendu de Couleur) indique le niveau de distorsion entre la couleur réelle vue à la lumière du jour et cette même couleur vue sous un éclairage artificiel.



Ce qui distingue la marque

MALLTIS

- ✓ Références pour les pro
- ✓ Des IRC élevés
- ✓ Efficient : 1 watt = 220 lumens
- ✓ Garantie 5 ans
- ✓ Références dimmables
- ✓ Une GU10 5000K
- ✓ Dépolie extérieur
- ✓ Fabrication sur mesure (*)

(*) pour les profilés et rubans LED



Emballage 100% carton.
Facing horizontal ou verticale



APPLIQUE LINOLITE

Ref	Barcode	Finit.	Culot	l (mm)	L (mm)	H (mm)	Watts	Prise	IP	Max W	PoseUVC	Recycle	N.B.	TM
AVEC PRISE ET INTERRUPTEUR														
12232	3661925122320	Blanc	S19	70	435	61		1x220V	IP20	60W	⊕	1	2	MALLTIS

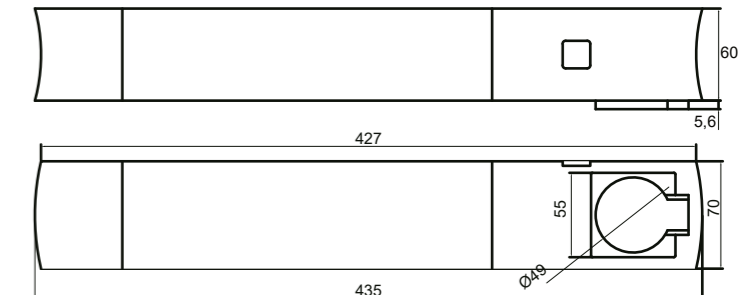
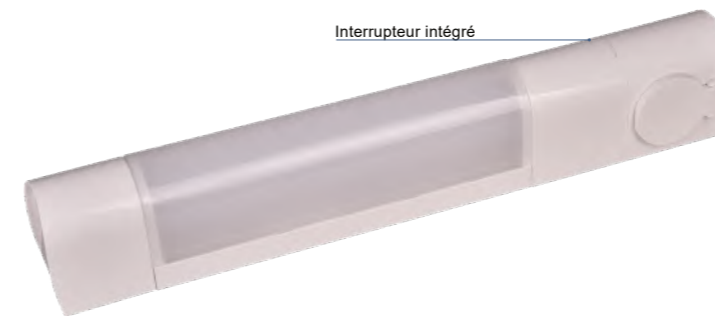

Ce luminaire fonctionne avec un tube LED S19 interchangeable.

Tubes recommandés
MALLTIS

Choisissez la température d'éclairage qui vous convient :
↳ 11223 : 9W - 806 lumens - 3000K (blanc chaud) - IRC90
↳ 11224 : 9W - 806 lumens - 4000K (blanc neutre) - IRC90



Vendu séparément



IRC90 pour une couleur plus naturelle

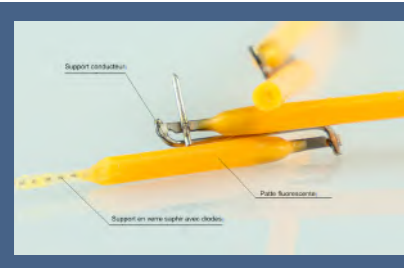

LED FILAMENT (COB)

Les LED filament appartiennent à la famille des LED de type COB (Chip On Board). Par rapport à la LED SMD, plusieurs puces miniatures seront incluses dans le substrat phosphorescent. Pour améliorer le refroidissement de ce type de technologie, la LED est mis dans une perle de verre rempli à l'hélium pour améliorer la dissipation de la chaleur.

AMPOULE LED FILAMENT

Ref		Culot	Watts	W=	Lumen	°K	Angle	☼	IRC	Finit.	Ø (mm)	H (mm)	UVC	☼	N.B.	TM
GLOBE																
15329		E27	8	60	806	4 000	320	Non	80	Milky	80	120	☼	1 2		ELUZIA F
STANDARD																
17842		B22	6	60	1 110	3 000	360	Non	80	Milky	60	105	☼	1 10		ELUZIA B
17843		B22	6	60	1 110	4 000	360	Non	80	Milky	60	105	☼	1 10		ELUZIA B
15330		B22	8	60	806	4 000	360	Non	80	Milky	60	105	☼	1 10	x	ELUZIA F
16828		B22	4	60	806	4 000	360	Non	80	Clair	60	105	☼	1 10		ELUZIA B
17827		B22	4	60	806	3 000	360	Non	80	Milky	60	105	☼	1 10		ELUZIA B
17828		B22	4	60	806	4 000	360	Non	80	Milky	60	105	☼	1 10		ELUZIA B
15337		B22	12	100	1 521	4 000	360	Non	80	Clair	67	120	☼	1 10		ELUZIA E
17831		B22	8	60	1 521	3 000	360	Non	80	Milky	60	105	☼	1 10		ELUZIA B
17832		B22	8	60	1 521	4 000	360	Non	80	Milky	60	105	☼	1 10		ELUZIA B
16827		B22	4	60	806	3 000	360	Non	80	Clair	60	105	☼	1 10		ELUZIA B
16831		B22	8	100	1 521	3 000	360	Non	80	Clair	60	105	☼	1 10		ELUZIA B
16832		B22	8	100	1 521	4 000	360	Non	80	Clair	60	105	☼	1 10		ELUZIA B
17840		E27	6	60	1 110	3 000	360	Non	80	Milky	60	105	☼	1 10		ELUZIA B
17841		E27	6	60	1 110	4 000	360	Non	80	Milky	60	105	☼	1 10		ELUZIA B
15324		E27	8	60	806	2 700	360	Non	80	Milky	60	105	☼	1 10	x	ELUZIA F
15326		E27	8	60	806	4 000	360	Non	80	Milky	60	105	☼	1 10		ELUZIA F
16826		E27	4	60	806	4 000	360	Non	80	Clair	60	105	☼	1 10		ELUZIA B
17825		E27	4	60	806	3 000	360	Non	80	Milky	60	105	☼	1 10		ELUZIA B
17826		E27	4	60	806	4 000	360	Non	80	Milky	60	105	☼	1 10		ELUZIA B
18825		E27	4	60	806	3 000	360	Non	80	Milky	60	105	☼	4 10		ELUZIA B
18826		E27	4	60	806	4 000	360	Non	80	Milky	60	105	☼	4 10		ELUZIA B
17829		E27	8	60	1 521	3 000	360	Non	80	Milky	60	105	☼	1 10		ELUZIA B
17830		E27	8	60	1 521	4 000	360	Non	80	Milky	60	105	☼	1 10		ELUZIA B
16825		E27	4	60	806	3 000	360	Non	80	Clair	60	105	☼	1 10		ELUZIA B
16829		E27	8	100	1 521	3 000	360	Non	80	Clair	60	105	☼	1 10		ELUZIA B
16830		E27	8	100	1 521	4 000	360	Non	80	Clair	60	105	☼	1 10		ELUZIA B

Ref		Culot	Watts	W=	Lumen	°K	Angle	☼	IRC	Finit.	Ø (mm)	H (mm)	UVC	☼	N.B.	TM
MINI SPHERIQUE																
16814		E14	6	78	1 110	3 000	360	Non	80	Clair	45	78	☼	1 10		ELUZIA B
16815		E14	6	78	1 110	4 000	360	Non	80	Clair	45	78	☼	1 10		ELUZIA B
17814		E14	6	78	1 110	3 000	360	Non	80	Milky	45	78	☼	1 10		ELUZIA B
17815		E14	6	78	1 110	4 000	360	Non	80	Milky	45	78	☼	1 10		ELUZIA B
15318		E14	4	40	470	4 000	360	Non	80	Milky	45	78	☼	1 10		ELUZIA E
16809		E14	2,5	40	470	3 000	360	Non	80	Clair	45	78	☼	1 10		ELUZIA B
16810		E14	2,5	40	470	4 000	360	Non	80	Clair	45	78	☼	1 10		ELUZIA B
17809		E14	2,5	40	470	3 000	360	Non	80	Milky	45	78	☼	1 10		ELUZIA B
17810		E14	2,5	40	470	4 000	360	Non	80	Milky	45	78	☼	1 10		ELUZIA B
15328		B22	4	40	470	4 000	360	Non	80	Milky	45	78	☼	1 10	x	ELUZIA E
17816		B22	2,5	78	470	3 000	360	Non	80	Milky	45	78	☼	1 10		ELUZIA B
16820		B22	4	60	806	3 000	360	Non	80	Clair	45	78	☼	1 10		ELUZIA B
16821		B22	4	60	806	4 000	360	Non	80	Clair	45	78	☼	1 10		ELUZIA B
17820		B22	4	60	806	3 000	360	Non	80	Milky	45	72	☼	1 10		ELUZIA B
17821		B22	4	60	806	4 000	360	Non	80	Milky	45	72	☼	1 10		ELUZIA B
16823		E27	6	78	1 110	3 000	360	Non	80	Clair	45	78	☼	1 10		ELUZIA B
16824		E27	6	78	1 110	4 000	360	Non	80	Clair	45	78	☼	1 10		ELUZIA B
17823		E27	6	78	1 110	3 000	360	Non	80	Milky	45	72	☼	1 10		ELUZIA B
17824		E27	6	78	1 110	4 000	360	Non	80	Clair	45	72	☼	1 10		ELUZIA B
15320		E27	4	40	470	2 700	360	Non	80	Milky	45	74	☼	1 10		ELUZIA E
15322		E27	4	40	470	4 000	360	Non	80	Milky	45	78	☼	1 10	x	ELUZIA E
16817		E27	2,5	40	470	3 000	360	Non	80	Clair	45	78	☼	1 10		ELUZIA B
16818		E27	2,5	40	470	4 000	360	Non	80	Clair	45	78	☼	1 10		ELUZIA B
17817		E27	2,5	40	470	3 000	360	Non	80	Milky	45	78	☼	1 10		ELUZIA B
17818		E27	2,5	40	470	4 000	360	Non	80	Milky	45	78	☼	1 10		ELUZIA B

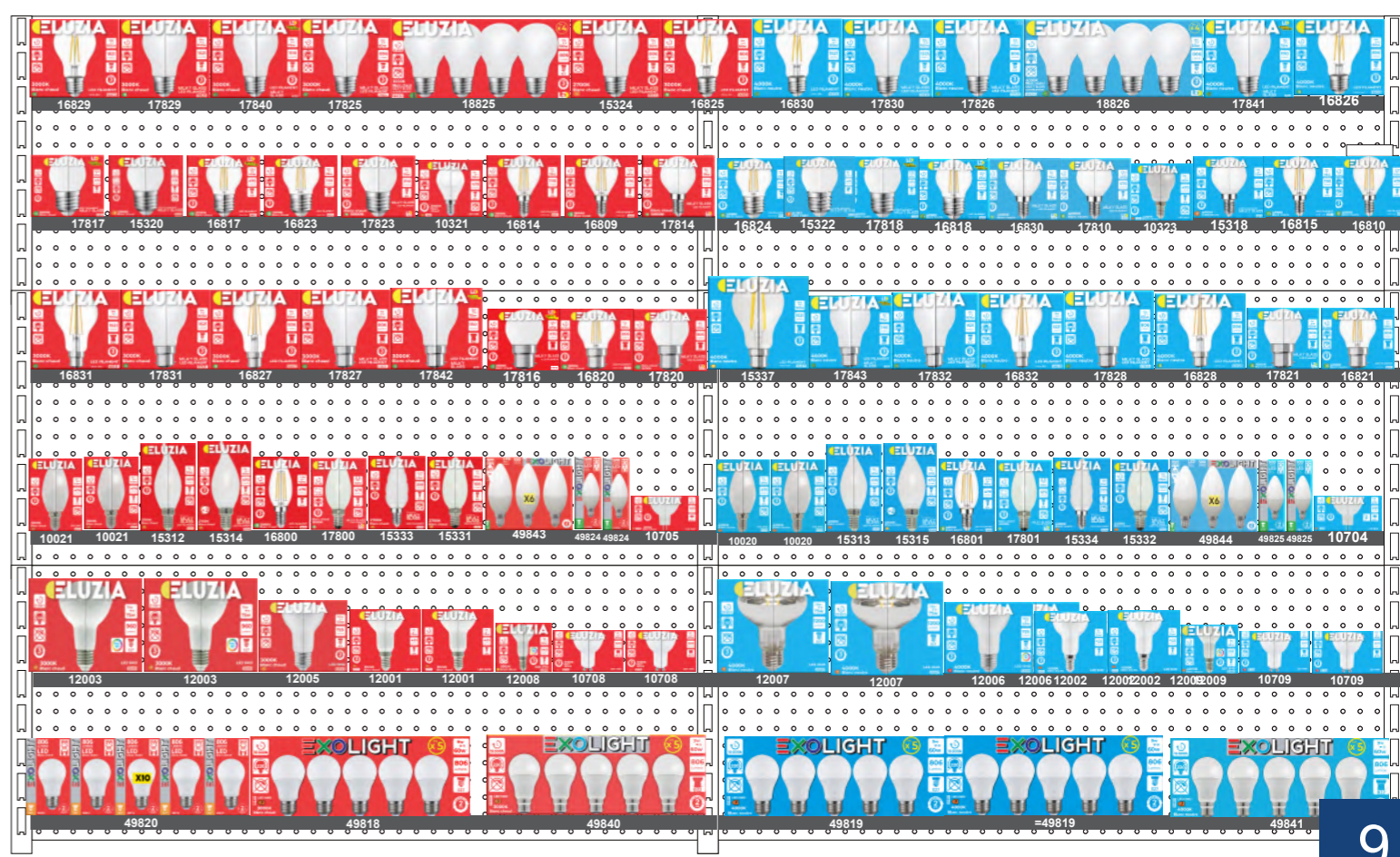



la boîte qui cartonne !



Blanc neutre 4000K

Blanc chaud 3000K



Ref	Barcode	Culot	Watts	W=	Lumen	°K	Angle	☼	IRC	Finit.	Ø (mm)	H (mm)	UVC	🔧	N.B.	TM	
FLAMME LISSE																	
15331	3661925153317	E14	1	10	100	3 000	320	Non	80	Milky	36	100	☼	1	10	🔧	ELUZIA F
15332	3661925153324	E14	1	10	100	4 000	320	Non	80	Milky	36	100	☼	1	10	🔧	ELUZIA F
16800	3661925168007	E14	2,5	40	470	3 000	320	Non	80	Clair	35	98	☼	1	10	🔧	ELUZIA B
16801	3661925168014	E14	2,5	40	470	4 000	320	Non	80	Clair	35	98	☼	1	10	🔧	ELUZIA B
17800	3661925178006	E14	2,5	40	470	3 000	320	Non	80	Milky	35	110	☼	1	10	🔧	ELUZIA B
17801	3661925178013	E14	2,5	40	470	4 000	320	Non	80	Milky	35	110	☼	1	10	🔧	ELUZIA B
FLAMME TORSADÉE																	
15333	3661925153331	E14	2,5	25	250	3 000	320	Non	80	Milky	36	100	☼	1	10	🔧	ELUZIA F
15334	3661925153348	E14	2,5	25	250	4 000	320	Non	80	Milky	36	100	☼	1	10	🔧	ELUZIA F
FLAMME COUP DE VENT																	
15312	3661925153126	E14	4	40	470	2 700	320	Non	80	Milky	35	113	☼	1	10	🔧	ELUZIA F
15313	3661925153133	E14	4	40	470	4 000	320	Non	80	Milky	35	113	☼	1	10	🔧	ELUZIA F
15314	3661925153140	E14	4	40	470	2 700	320	Non	80	Milky	35	113	☼	2	10	🔧	ELUZIA F
15315	3661925153157	E14	4	40	470	4 000	320	Non	80	Milky	35	113	☼	2	10	🔧	ELUZIA F
TUBE																	
10578	3661925105781	E14	2	20	250	2 700	320	Non	80	Clair	25	80	☼	1	10	🔧	ELUZIA E
CRAYON																	
16222	3661925162227	R7S	9	70	1 055	3 000	270	Non	LED	80	16	118	☼	1	10	🔧	ELUZIA E
16226	3661925162265	R7S	9	75	1 055	4 000	270	Non	LED	80	16	118	☼	1	10	🔧	ELUZIA E

Évolution de l'efficacité des LED

Nombre de lumens produits par watt consommé (lm/W)

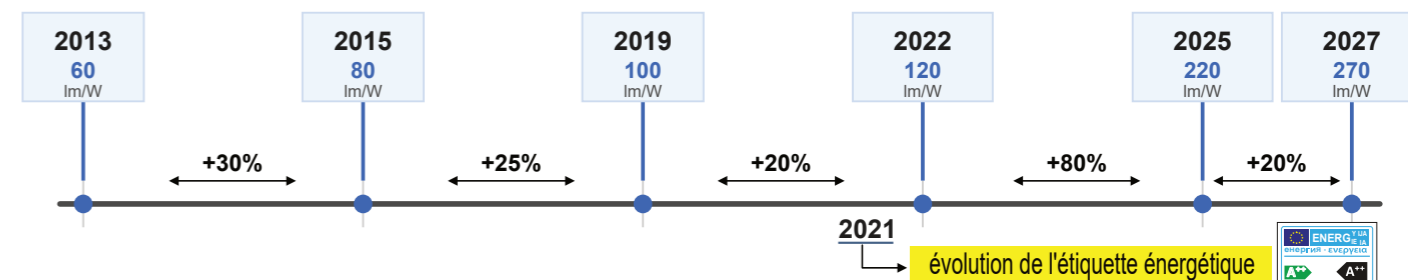

ELUZIA Classe énergétique **B** = -50% Économie d'énergie sur les LED 1ère génération

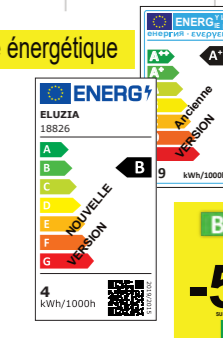

B d'aujourd'hui = -50% **A++** d'hier

Avantages

- + Vos clients sont autonomes pour trouver la bonne ampoule.
- + Risque d'erreur réduit.
- + Ce qui se voit bien se vend plus.
- + Gain de productivité. Temps de recharge rapide et efficace.

Pour une mise en place structurée, nous vous proposons notre solution avec séparateur réversible, compatible poussoir à tabac.





SMD (Surface Mounting Device)

La LED SMD se distingue des LED de type COB (Chip On Board). C'est ce composant qui va définir la couleur obtenue. La couleur jaune est un substrat phosphorescent qui va diffuser la lumière.



AMPOULE LED SMD

Ref	Colot	Watts	W=	Lumen	°K	Angle	Varia.	IRC	Finit.	Ø (mm)	H (mm)	UVC	N.B.	TM
A63 - STRONG														
450071	E27	17	110	1 700	4 000	180	Non	80	Opale	64	133	1	1	ELUZIA
GLOBE														
10319	E27	15	100	1 521	3 000	180	Non	80	Opale	120	162	1	4	ELUZIA
10329	E27	15	100	1 521	4 000	180	Non	80	Opale	120	162	1	4	ELUZIA
STANDARD														
10357	E27	15	100	1 521	6 000	220	Non	80	Opale	70	128	1	6	ELUZIA
MINI SPHERIQUE														
10321	E14	5	40	470	3 000	150	Non	80	Opale	45	78	1	10	ELUZIA
10331	E14	5	40	470	6 000	220	Non	80	Opale	45	78	1	6	ELUZIA
FLAMME LISSE														
450036	E14	4,5	28	420	6 000	200	Non	80	Opale	37	99	1	10	ELUZIA
10020	E14	5	40	470	4 000	180	Non	80	Opale	37	107	1	10	ELUZIA
10021	E14	5	40	470	3 000	180	Non	80	Opale	37	107	1	10	ELUZIA
450039	E14	9	60	900	6 000	200	Non	80	Opale	37	106	1	10	ELUZIA
450040	E27	6	40	470	3 000	200	Non	80	Opale	37	99	1	10	ELUZIA
450041	E27	6	40	470	4 000	200	Non	80	Opale	37	99	1	10	ELUZIA
450042	E27	6	40	470	6 000	200	Non	80	Opale	37	99	1	10	ELUZIA

Ref	Colot	Watts	W=	Lumen	°K	Angle	Varia.	IRC	Finit.	Ø (mm)	H (mm)	UVC	N.B.	TM
SPOT R39														
12009	E14	3	23	250	4 000	120	Non	90	Opale	39	67	1	10	ELUZIA
12008	E14	3	23	340	3 000	120	Non	90	Opale	39	67	1	10	ELUZIA
SPOT R50														
12001	E14	5	35	423	3 000	120	Non	90	Opale	50	83	1	10	ELUZIA
12002	E14	5	35	423	4 000	120	Non	90	Opale	50	83	1	10	ELUZIA
12012	E14	5	35	423	6 000	120	Non	90	Opale	50	83	1	6	ELUZIA
SPOT R60														
12005	E27	8,5	60	725	3 000	120	Non	80	Opale	63	108	1	10	ELUZIA
12006	E27	8,5	60	725	4 000	120	Non	90	Opale	63	108	1	10	ELUZIA
12010	E27	8,5	60	725	6 000	120	Non	90	Opale	63	108	1	6	ELUZIA
SPOT R80														
12011	E27	11	75	930	6 000	120	Non	90	Opale	80	110	1	6	ELUZIA
12003	E27	11	75	950	3 000	120	Non	90	Opale	80	110	1	6	ELUZIA
12007	E27	12	75	1 200	4 000	120	Non	80	Opale	80	110	1	10	ELUZIA
PAR16														
10708	GU10	7	40	560	3 000	100	Non	90	Clair	50	57	1	10	ELUZIA
10709	GU10	7	40	560	4 000	100	Non	90	Clair	50	57	1	10	ELUZIA
450030	GU10	7	70	615	6 500	100	Non	80	Blanc	50	55	1	10	ELUZIA
450033	GU10	10	80	900	6 500	120	Non	80	Blanc	50	57	1	10	ELUZIA
MR16														
10704	GU5,3	6	40	450	4 000	35	Non	80	Clair	50	52	1	10	ELUZIA
10705	GU5,3	6	40	450	3 000	35	Non	80	Clair	50	50	1	10	ELUZIA
GX53														
10385	GX53	5	40	470	4 000	300	Non	80	Opale	75	28	1	6	ELUZIA



Dorénavant tous nos emballages sont majoritairement en carton recyclable. Progressivement tous les blisters plastiques disparaissent au profit d'emballage en carton plus facilement recyclable. Pour gérer la transition, les blisters cartons peuvent indifféremment être positionné sur tablette ou sur broche. Les produits brochables sont identifiés par ce picto dans les tableaux de ce catalogue.



Évolution de l'étiquette label énergie :

9W +/-
806 lumen
=60W incandescent

A

Ce geste va vous faire économiser :

-50% minimum sur vos LED 1ère génération !

-90% minimum sur vos ampoules incandescentes !

Angle d'éclairage

330°

LED FILAMENT

LED SMD

220°
180°

Une marque taillée pour les prix discount

- ✓ Une gamme proposée exclusivement par lots
- ✓ Conçue pour vous positionner aux meilleurs prix
- ✓ Box promotionnel à votre disposition par quantité

AMPOULE LED SMD

Ref		Culot	Watts	W=	Lumen	°K	Angle	☼	IRC	Finit.	Ø (mm)	H (mm)	UVC	☼	N.B.	TM	Gencod unitaire	
STANDARD																		
49840	3661925498401	B22	9	60	806	3 000	270	Non	80	Opale	60	110	☼	5	10	☼	EXOLIGHT F	3661925199346
49841	3661925498418	B22	9	60	806	4 000	220	Non	80	Opale	60	110	☼	5	10	☼	EXOLIGHT F	3661925199346
49818	3661925498180	E27	9	60	806	3 000	270	Non	80	Opale	60	108	☼	5	10	☼	EXOLIGHT F	3661925498142
49819	3661925498197	E27	9	60	806	4 000	270	Non	80	Opale	60	108	☼	5	10	☼	EXOLIGHT F	3661925498159
MINI SPHERIQUE																		
49929	3661925499293	E14	5	40	470	4 000	150	Non	80	Opale	45	80	☼	4	10	☼	EXOLIGHT F	3661925199262
49931	3661925499316	E14	5	40	470	3 000	150	Non	80	Opale	45	80	☼	4	10	☼	EXOLIGHT F	3661925199315
FLAMME LISSE																		
49843	3661925498432	E14	6	45	500	3 000	270	Non	80	Opale	37	100	☼	6	10	☼	EXOLIGHT G	3661925498241
49844	3661925498449	E14	6	45	500	4 000	270	Non	80	Opale	37	100	☼	6	10	☼	EXOLIGHT G	3661925498258
SPOT R50																		
49925	3661925499255	E14	5	40	420	4 000	180	Non	80	Opale	50	85	☼	4	10	☼	EXOLIGHT G	3661925199254
49930	3661925499309	E14	5	40	420	3 000	180	Non	80	Opale	50	85	☼	4	10	☼	EXOLIGHT F	3661925199308
PAR16																		
49826	3661925498265	GU10	6	40	500	3 000	100	Non	80	Opale	50	55	☼	4	10	☼	EXOLIGHT G	3661925199261
CAPSULE																		
49829	3661925498296	G9	4	40	350	4 000	330	Non	80	Clair	15	55	☼	3	10	☼	EXOLIGHT F	-
49830	3661925498302	G9	4	40	350	3 000	330	Non	80	Clair	15	55	☼	2	10	☼	EXOLIGHT F	-

BOX CARTON



Vendu exclusivement par lot

mais qui peut être "déloté" avec un gencod individuel





AMPOULE HALOGENE

Ref	Barcode	Culot	Watts	W=	Lumen	°K	Angle	Techno	IRC	Ø (mm)	L (mm)	UVC	N.B.	TM
CRAYON														
18032	3661925180320	R7S	120	150	2 216	2 700	360	Oui	Halo	100	10	78	2 12	ELUZIA G
18036	3661925180368	R7S	120	150	2 250	2 700	360	Oui	Halo	100	10	118	2 12	ELUZIA G

AMPOULES FOUR

Ref	Barcode	Culot	Volt.	Watts	°C	°K	Angle	Techno	IRC	Ø (mm)	L (mm)	UVC	N.B.	TM
POIRETTE														
11251	3661925112512	E14	220	15	300°	2 700	360	Oui	Incand.	100	22	45	1 10	ELUZIA G
CAPSULE														
12438	3661925124386	G9	220	25	300°	2 800	360	Oui	Incand	100	14	46	1 10	ELUZIA G

AMPOULES FRIGO

Ref	Barcode	Culot	Volt.	Watts	Angle	°K	Techno	IRC	Ø (mm)	H (mm)	UVC	N.B.	TM	
POIRETTE														
10574	3661925105743	E14	2	220	320	6 000	Non	LED	80	26	58	1 10	ELUZIA F	

AMPOULE GUIRLANDE

Ref	Barcode	Culot	Watts	W=	Lumen	°K	Angle	IRC	Ø (mm)	H (mm)	UVC	N.B.	TM	
MINI SPHERIQUE														
47606	3661925476065	E27	1	-	Rouge	320	Non	80	45	79	10 10	ELUZIA G		
47607	3661925476072	E27	1	-	Jaune	320	Non	80	45	79	10 10	ELUZIA G		
47608	3661925476089	E27	1	-	Bleu	320	Non	80	45	79	10 10	ELUZIA G		
47609	3661925476096	E27	1	-	Vert	320	Non	80	45	79	10 10	ELUZIA G		
47616	3661925476164	E27	1	-	Rouge	320	Non	80	45	79	1 10	ELUZIA G		
47617	3661925476171	E27	1	-	Jaune	320	Non	80	45	79	1 10	ELUZIA G		
47618	3661925476188	E27	1	-	Bleu	320	Non	80	45	79	1 10	ELUZIA G		
47619	3661925476195	E27	1	-	Vert	320	Non	80	45	79	1 10	ELUZIA G		

AMPOULE IODURE

Ref	Barcode	Culot	Volt.	Watts	Angle	°K	Techno	IRC	Ø (mm)	H (mm)	UVC	N.B.	TM	
TUBULAIRE														
19830	3662094200802	E40	500	220	320	2 700	Oui	Halo	100	38	225	1 1	x	G
19831	3662094200819	E40	1 000	220	320	2 700	Oui	Halo	100	38	260	1 1	x	G

AMPOULE INCANDESCENTE

Ref	Barcode	Culot	Volt.	Watts	Angle	°K	Techno	IRC	Ø (mm)	H (mm)	UVC	N.B.	TM	
TUBE														
10492	3661925104920	E14	25	220	320	2 700	Oui	Incand	100	28	80	2 10	ELUZIA G	
TUBULAIRE														
10497	3661925104975	B22	25	220	320	2 700	Oui	Incand	100	28	80	2 10	ELUZIA G	

TUBE LED EN VERRE



Les tubes en verre sont une solution grand public.

Pour un usage intensif et pour les opérations dit de « relamping », il faudra privilégier un tube avec refroidisseur en aluminium de la gamme Maltis.



STARTER SHUNTER

Les starters « shunter » sont fournis de série avec nos tubes

Ils s'utilisent avec une réglette de type ferro-magnétique.

Ce starter permet de convertir une réglette fluorescente en réglette LED (ne fonctionne pas pour les modèles équipés d'un ballast électronique, mais uniquement des modèles avec ballast ferromagnétique).

N.B. : Veillez à ne pas confondre les 2 types de starters, ils ne sont pas compatibles.



Nouveau conditionnement

TUBES LED EN VERRE

Ref	Barcode	Culot	Watts	Techno	Lumen	°K	Ø (mm)	Angle	IRC	Finit.	UVC	N.B.	TM	
T8 0M60														
10627	3661925106276	G13	9	LED	900	4 000	26	220	Non	80	Opale	1 6	ELUZIA E	
T8 0M90														
10611	3661925106115	G13	14	LED	1 200	4 000	13	270	Non	80	Opale	1 25	x MALTIS F	
T8 1M20														
16673	3661925166737	G13	18	LED	2 340	4 000	26	200	Non	80	Opale	1 16	ELUZIA E	
T8 1M50														
16623	3661925166232	G13	22	LED	2 860	4 000	26	200	Non	80	Opale	1 16	ELUZIA E	

STARTER SHUNTER

Ref	Barcode	Techno	UVC	N.B.	TM
STARTER					
10647	3661925106474	LED	-	1 10	ELUZIA
10648	3661925106481	LED	-	4 4	ELUZIA

Ne pas utiliser le starter shunter avec une réglette équipée d'un tube fluorescent.

Compatibles avec les réglettes équipées de ballast ferromagnétique (présence d'un starter).

T8 0M90



Pour éclairer les gondoles de 1m type Maiso.de la presse

T8 0M60



Pour remplacer les tubes fluo d'un luminaire composé de 4 tubes, le starter shunter ne conviendra pas. Il faudra modifier le cablage du luminaire. De même pour une réglette composée de 2 tubes de 60 cm, car le luminaire utilise 1 driver qui pilote 2 tubes. Flashez le QR code pour en savoir plus.

Privilégiez l'utilisation d'un panel LED, qui sera plus performant.

Règles de montage



Concernant les évolutions réglementaires, vos stocks d'halogène, HDE... restent autorisés à la vente, seul les importations et la fabrication de ces références sont interdites par l'Europe.



DOWNLIGHT

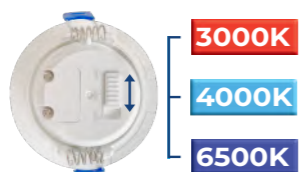

DOWNLIGHT

Ref	Watts	Lumen	°K	Angle	Ø (mm)	H (mm)	IP	Finition	UVC	N.B.	TM
3000 - 4000 - 6500 K											
49715	7	650-735	CCT	38°	85	40	IP40	Blanc	10	1	ELUZIA

RONDELLES

Ref	Forme	Ø (mm)	Matériau	Fonction	IP	Finition	UVC	N.B.	TM
Basculant									
14105	Rond	96	Acier	Basculant	IP20	Brossé	1	10	kob
14206	Rond	93	Acier	Basculant	IP20	Chrome	1	10	kob
14207	Rond	93	Acier	Basculant	IP20	Graphite	1	10	kob
14208	Rond	84	Acier	Basculant	IP20	Chrome mat	1	10	kob
14104	Rond	96	Acier	Basculant	IP20	Blanc	1	10	kob
Fixe									
14103	Rond	82	Acier	Fixe	IP20	Brossé	1	10	kob
14102	Rond	82	Acier	Fixe	IP20	Blanc	1	10	kob
14403	Carré	150	Plâtre	Fixe	IP20	Blanc	1	1	kob
14118	Carré	96	Acier	Fixe	IP20	Noir	1	10	kob
Étanche									
14107	Rond	83	Acier	Fixe	IP44	Brossé	1	6	kob
14106	Rond	83	Acier	Fixe	IP44	Blanc	1	6	kob
14130	Rond	83	Acier	Fixe	IP44	Noir	1	6	kob

DOUILLES

Ref	Culot	UVC	N.B.	TM
14100	GU10	1	6	ELUZIA
14101	GU5.3	1	5	ELUZIA

PROJECTEUR DE SOL

Ref	Culot	Watts	Finit.	H (mm)	Ø (mm)	IP	UVC	N.B.	TM
14451	GU10/GU5.3	50 Max	Chrome	125	103	80 65	1	1	kob

HUBLOTS

Ref	Watts	Lumen	Varia.	Angle	°K	Défect	Ø (mm)	L (mm)	H (mm)	IP	UVC	N.B.	TM
Ovale													
16507		1 050	Non	120	4 000	Non	105	210	48	IP54	1	10	ELUZIA
Rond													
10506	12	840	Non	120	4 000	Non	210		82	IP54	1	10	ELUZIA

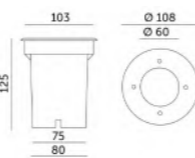

Rationaliser vos stocks !

Ne jetez plus un projecteur pour un détecteur en panne
100 lumens/watt (contre 80 lumens habituellement)



Réglage par télécommande

série "STARLINE" ★★★★★

PROJECTEUR 220V

Ref	Techno	Watts	Lumen	Finit.	°K	H (mm)	I (mm)	L (mm)	IP	Défect.	Poids (kg)	UVC	N.B.	TM
STARLINE														
16730	LED	10	1 000	Noir	4 000	26	104	104	IP65	Option	0,2	1	1	ELUZIA
16735	LED	30	3 000	Noir	4 000	30	136	188	IP65	Option	0,5	1	1	ELUZIA
16740	LED	50	5 000	Noir	4 000	32	160	221	IP65	Option	0,7	1	1	ELUZIA
16745	LED	100	10 000	Noir	4 000	33	226	242	IP65	Option	1,5	1	1	ELUZIA

DÉTECTEUR "PLUGABLE"

16729	Infra rou	Noir	IP54	1	1	ELUZIA
-------	-----------	------	------	---	---	--------



Batterie amovible



PROJECTEUR SOLAIRE

Ref	Watts	Lumen	°K	Finit.	H (mm)	I (mm)	L (mm)	IP	Défect	Batterie	Ampèr.	UVC	N.B.	TM
MONOBLOC														
10750	6		CCT	Noir	44	97	143	IP65	Oui	Amovible	2,2	1	4	ELUZIA
10751	8		CCT	Noir	44	97	194	IP65	Oui	Amovible	2,6	1	1	ELUZIA

DÉTECTEUR DE PRESENCE

Ref	Fonct.	Angle	Finit.	IP	H (mm)	L (mm)	I (mm)	Techno	UVC	N.B.	TM
INFRA ROUGE											
10571	Présence	180	Noir	IP54	83	95	86	Infra rouge	1	6	kob
22292	Présence	180	Blanc	IP54	83	95	86	Infra rouge	1	6	kob
HAUTE FREQUENCE											
20104	Présence	180	Blanc	IP20	37,2	54,5	39,4	Hautre fréquence	1	1	kob

ACCESSOIRES PROJECTEURS

Ref	UVC	N.B.	TM
PIQUET			
80001	1	1	MALLTS
POTENCE			
80007	1	1	MALLTS





Connecteurs rapide

Faible épaisseur

Montage facile

REGLETTE 1ER PRIX

Ref	Watts	Techno	Culot	Tube	°K	Lumen	L(mm)	I(mm)	H(mm)	IP	Délect.	UVC	N.B.	TM
1m20														
13385	18	LED	-	Intégré	1750	1230	53	35	IP65	Non	Ⓢ	1 20	ELUZIA	D
1m50														
13386	24	LED	-	Intégré	2300	1510	53	35	IP65	Non	Ⓢ	1 20	ELUZIA	D

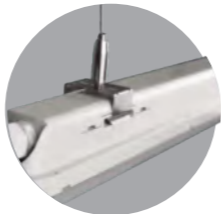
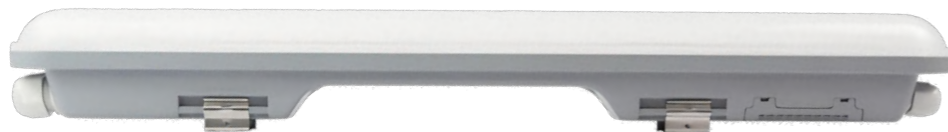

Connectable

Connecteurs rapide

Trappe d'accès

LED sur PCB

REGLETTE CONNECTABLE AVEC LED INTÉGRÉE

Ref	Watts	Techno	Culot	°K	Lumen	L(mm)	I(mm)	H(mm)	IP	Délect.	UVC	N.B.	TM		
1M20															
13880	18	LED	-	14	4000	1800	1150	58	58	IP65	Non	Ⓢ	1 12	ELUZIA	D
13881	36	LED	-	12	4000	3600	1150	78	58	IP65	Non	Ⓢ	1 8	ELUZIA	D
1M50															
13882	24	LED	-	10	4000	2400	1450	58	58	IP65	Non	Ⓢ	1 12	ELUZIA	D
13883	48	LED	-	9	4000	4800	1450	78	58	IP65	Non	Ⓢ	1 8	ELUZIA	D



REGLETTE LIVRÉE SANS TUBE



Tube T8

Presse étoupe

Ref	Watts	Techno	Culot	Tube	°K	Lumen	L(mm)	I(mm)	H(mm)	IP	Délect.	UVC	N.B.	TM		
OM60																
601732	5900605099384	Livré ss tube	LED	G13	vendu séparément	600	68	58	IP65	Non	Ⓢ	1 1	kobi	Ⓢ		
1M20																
13972	3661925139724	36	LED	G13	2x18W	4000	3150	1284	96	60	IP65	Non	Ⓢ	1 12	ELUZIA	D
13973	3661925139731	48	LED	G13	2x24W	4000	4200	1584	96	60	IP65	Non	Ⓢ	1 12	ELUZIA	D
1M50																
13970	3661925139700	18	LED	G13	1x18W	4000	1620	1284	62	60	IP65	Non	Ⓢ	1 12	ELUZIA	D
13971	3661925139717	24	LED	G13	1x24W	4000	2160	1584	96	60	IP65	Non	Ⓢ	1 8	ELUZIA	D



PANEL BACKLIGHT

Ref	Forme	Watt	Type	Lumen	°K	L (mm)	I (mm)	H (mm)	IP	UGR	UVC	N.B.	TM		
60x60															
42283	3661925422833	60x60	40	Backlite	4000	4000	595	595	10	IP40	<19	Ⓢ	1 8	ELUZIA	D
42284	3661925422840	60x60	40	Backlite	4000	5000	595	595	10	IP40	<19	Ⓢ	1 8	ELUZIA	D

ACCESSOIRES PANEL BACKLITE

Ref	Forme	Finit.	I (mm)	L (mm)	H (mm)	UVC	N.B.	TM	
60x60									
40975	3661925409759	60x60	Blanc	602	602	70	Ⓢ	1 1	MALITS

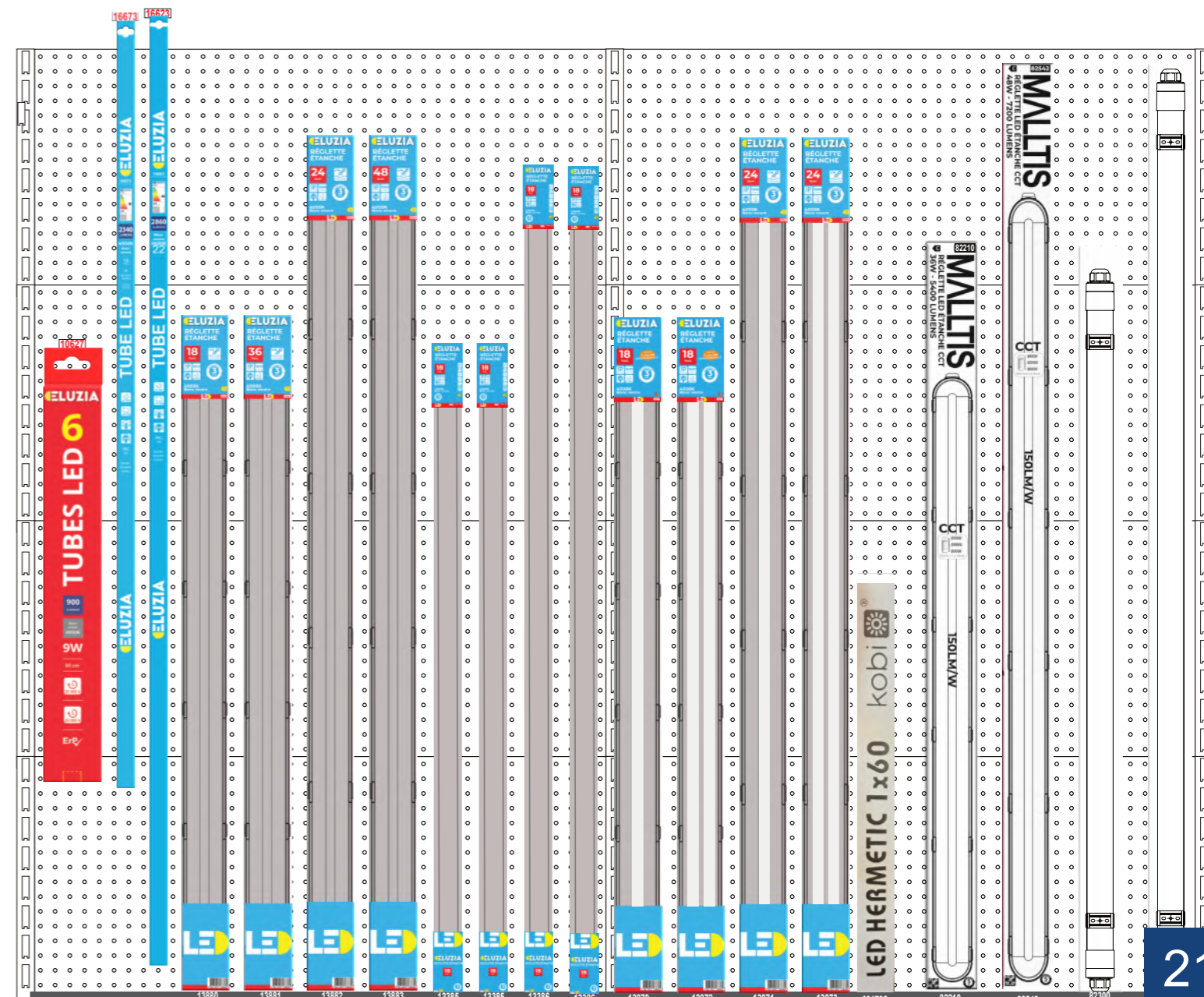



CCT



Indice de protection IP65

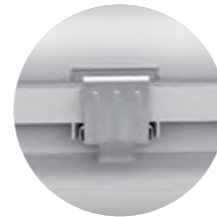

REGLETTE CLIPS INOX CONNECTABLE

Photo	Ref	Watts	Techno	°K	Lumen	L(mm)	l(mm)	H(mm)	IP	Délect.	UVC	N.B.	TM	
1M20														
	82210	3661925822107	36	LED	41	CCT	5 400	1 205	79	68	IP65	Non	Ⓢ	1 12
1M50														
	82542	3661925825429	48	LED	9	CCT	7 200	1 499	79	68	IP65	Non	Ⓢ	1 9
	82212	3661925825429	24-30-36-48	LED	31	CCT	7 200	1 499	79	68	IP65	Non	Ⓢ	1 9



REGLETTE U-LINE CONNECTABLE

Photo	Ref	Watts	Techno	Tube	°K	Lumen	L(mm)	l(mm)	H(mm)	IP	Délect.	UVC	N.B.	TM	
1M20															
	82300	3661925823005	36	LED	-	Intégré	CCT	4 320	1 572	47,5	59,5	IP65	Non	Ⓢ	1 15
1M50															
	82305	3661925823050	50	LED	-	Intégré	CCT	6 000	1 572	47,5	59,5	IP65	Non	Ⓢ	1 12



Haute efficacité
150 LM/W



Angles

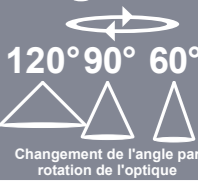

Changement de l'angle par rotation de l'optique

Watts



Kelvin



Photo	Ref	Angle	°K	IP	H (mm)	L (mm)	Poids (kg)	Connectique	UVC	N.B.	TM
HIGH BAY											
	81410	366192581410	60/90/120°	CCT : 3/4/5000	IP65	166	336	2,3		1 4	MALLTIS
ACCESSOIRES ZHAGA											
	81505	366192581505	Détecteur infra rouge							1 1	MALLTIS
	81507	366192581507	Télécommande							1 1	MALLTIS
CHAÎNE											
	81506	366192581506								1 1	MALLTIS

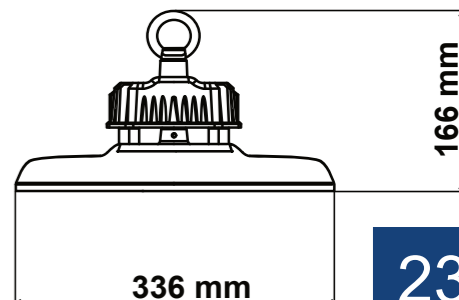



PANEL UGR<19

PANEL BACKLIGHT

Photo	Ref	Forme	Conso	Type	Lumen	°K	L (mm)	I (mm)	H (mm)	IP	UGR	UVC	N.B.	TM
60x60	31030	3661925310307	60x60	26W	3 600	4 000	595	595	32	IP40	<19	1	5	MALLTIS

ACCESSOIRES PANEL BACKLIT

Photo	Ref	Forme	Finit.	I (mm)	L (mm)	H (mm)	Gamme	UVC	N.B.	TM
60x60	40975	3661925409759	60x60	Blanc	602	602	70	1	1	MALLTIS

Diffuseur en PMMA

Ce qui fait la qualité du panel, c'est son diffuseur. Ce matériaux permet une qualité de diffusion optimale pour un meilleur rendement et également dispose d'un traitement pour éviter de jaunir avec le temps.



INSTALLATION & ACCESSOIRES



UGR<19

Les initiales UGR signifient « Unified Glare Rating ».

C'est l'indice du niveau d'éblouissement du luminaire. La norme EN 12464-1 pour les lieux de travail

La norme EN 124654-1 définit les valeurs UGR maximum pour les différentes zones de l'espace de travail.

Pour l'éclairage des bureaux tertiaires, la norme impose une valeur UGR <19.



Haute efficacité
120 LM/W



10 références en 1 !

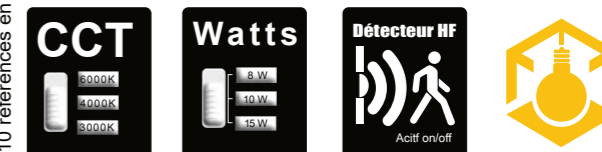

HUBLLOT ANTI-VANDALE

Photo	Ref	Watts	Lumen	Varia.	Angle	°K	Défect	Ø (mm)	L (mm)	I (mm)	H (mm)	IP	Forme	VC	N.B.	TM
31013	3661925310130	15	1800	Non	120	CCT	Oui	260			57	IP54	1	1	MALLTIS	

Sélection de puissance

Sélection couleur (3/4/6K)



Gestion détecteur

Interrupteur poussoir

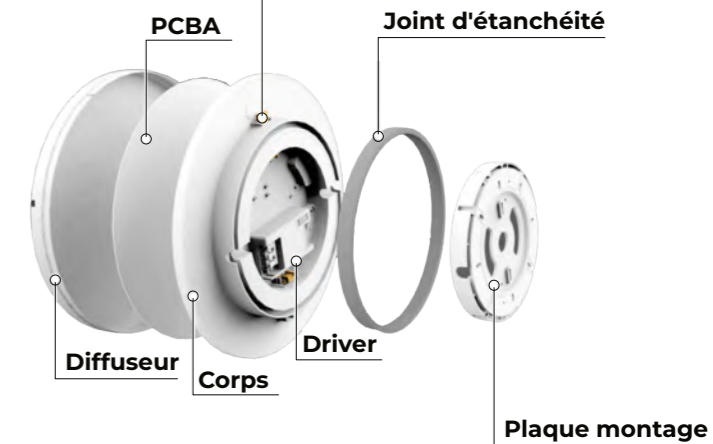

Vidéo de présentation





TECHNOLOGIE SMD



TECHNOLOGIE COB



RUBAN 220V

Photo	Ref	Long.	IP	W	°K	Lm/W	l(mm)	L(mm)	IRC	Angle	UVC	N.B.	TM
SMD													
	20000	366192520000	15m	IP65	129	5 000	114	20	Non	80	120	③	1 2
	20001	366192520001	25m	IP65	215	5 000	114	20	Oui	80	120	③	1 2
	20002	366192520002	25m	IP65	215	5 000	114	20	Oui	80	120	③	1 3
COB													
	20003	366192520003	15m	IP65	147	5 000	85	20	Oui	85	120	③	1 2
	20004	366192520004	25m	IP65	245	5 000	85	20	Oui	85	120	③	1 3

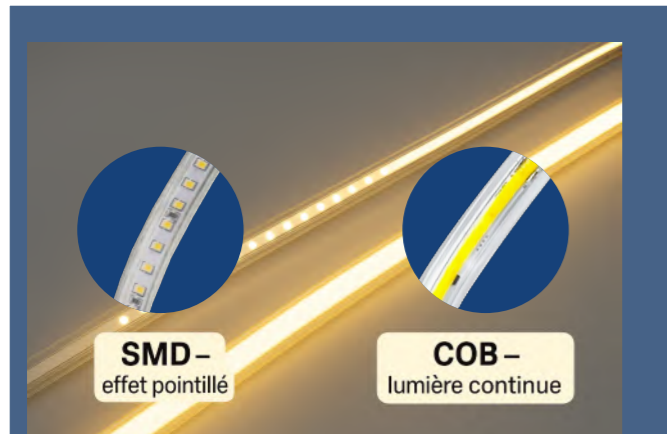

Pour un travail de précision la technologie COB est la solution idéale.

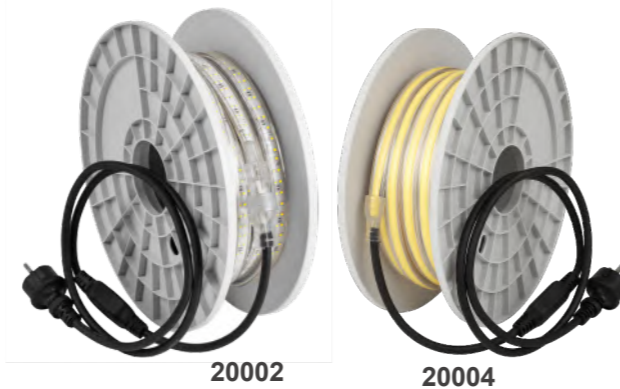

PROJECTEUR DE CHANTIER

Photo	Ref	Techno	Watts	Lumen	Portée l (mm)	L (mm)	H (mm)	IP	Longueur câble	UVC	N.B.	TM						
ELUZIA																		
	22655	366192522655	LED	50	4 200	25 m	310	80	320	80	IP54	3 m	80	③	1 4	✕	ELUZIA	G
	22656	366192522656	LED	2x30	5 650	20 m	280	190	220	190	IP65	3 m	80	③	1 4	✕	ELUZIA	F
	22687	366192522687	LED	50	6 500	25 m	310	80	320	80	IP65	3 m	80	③	1 1	✕	ELUZIA	D
	22682	366192522682	LED	100	11500	25 m	545	465	442	465	IP54	3 m	80	③	1 1	✕	ELUZIA	D

Un choix de couleur exclusif et technique :



5000K = blanc confort.

Ce choix de température de couleur permet d'obtenir une vision net des zones de travail. Le contraste des surfaces est optimal ce qui facilite le travail de précision. Idéal pour vos travaux de peinture, carrosserie...



PROJECTEURS SUR TREPIED

Photo	Ref	Techno	Watts	Lumen	°K	Portée	H(mm)	l(mm)	L(mm)	IP	L.cable	IRC	UVC	N.B.	TM		
	22658	366192522658	LED	50	4 200	5 000	25 m	1600	250	250	IP54	3 m	③	1 1	✕	ELUZIA	G
	22657	366192522657	LED	2x50	8 400	5 000	25 m	1600	102	27,5	IP54	3 m	③	1 1	✕	ELUZIA	G

TREPIEDS

Photo	Ref	Mat	Fini	H maxi	UVC	N.B.	TM		
	22389	366192522389	Acier	noir	1M60	③	1 1	✕	ELUZIA
	22701	366192522701	Acier	noir	2M00	③	1 1	✕	ELUZIA

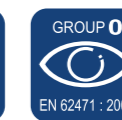



adaptateurs inclus pour : 

Black & Decker	Bosch	Dewalt	Festool
Hikoki	Makita	Metabo	Flex

Photos indicatives et non contractuelles

HYBRIDE
Batterie + 220V



GARANTIE 5 ANS

Photo	Ref	IP	Watts	Lumen	°K	L (mm)	L (mm)	H (mm)	Volt.	UVC	N.B.	TM
Projecteurs hybride												
	22681	366192522681	IP65	65	6500	5 000	532	350	345	24V + 220V	1	4

Photo	Ref	Marque	UVC	N.B.	TM
Adaptateur supplémentaire					
	22683	366192522683	Einhel	1	1



LAMPE FRONTALE

Photo	Ref	Watts	Type batterie	Autonomie	°K	UVC	N.B.	TM
	600035	590596333449	10	Li-Polymer 3, 7V	6h00	IP40	6500	1 1

LAMPE TORCHE

Photo	Ref	Watts Lum.	Type batterie	Autonomie	°K	UVC	N.B.	TM
	600011	590596360855	3	150	Li-ion 3, 7V	2h50	IP40	6 500
	600012	590596360856	5	400	Li-ion 3, 7V	2h50 - 4h00	IP40	6 500
	600013	590596360869	5	360	Li-ion 3, 7V	2h50 - 4h00	IP40	6 500
	22675	366192522675	10	1000	Li-ion 3, 7V	6h00	IP54	5 000

Armix

	30800	489709612056	6	800	Li-ion 3, 7V	8h00	IP67	5 000
	30801	489709612001	12	1600	Li-ion 3, 7V	8h00	IP67	5 000

Lumibar

	30825	489709612061	2	200	Li-ion 3, 7V	2h00	IP20	5 000
--	-------	--------------	---	-----	--------------	------	------	-------



LED RAYON

Sortez vos rayons de l'ombre



Nos autres catalogues



Pour valoriser vos linéaires, nous vous proposons la solution d'éclairage LED Rayon qui illumine et magnifie vos articles.

Notre médiathèque complète



Mise à jour très régulièrement

Besoin d'une étude d'éclairage ?

Prodeal la fait pour vous !

Pour réaliser vos projets, complétez les documents à télécharger via les QR Code ci-après :

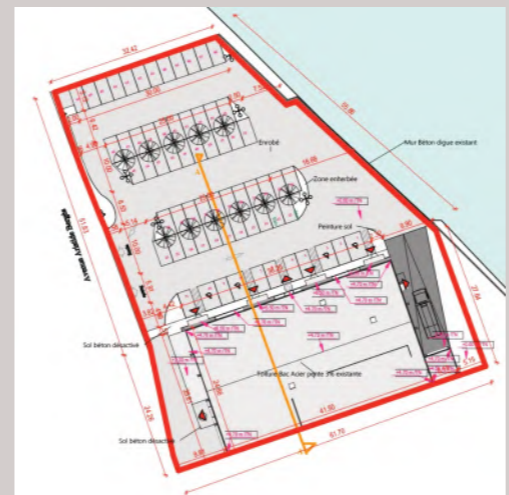

Relamping



Projet solaire





Siège social et Logistique :
ZI de Grâces
11 route de Kerbost
22200 GUINGAMP - France

+33 2 96 14 02 05
info@groupe-prodeal.com

SAS au capital de 300 003 €
Siret 751892274 - APE 4690Z
RCS SAINT-BRIEUC B 751 892 274
N° TVA intracommunautaire FR 34751892274

groupe-prodeal.com